

APPENDIX 10

**TO THE GENERAL CONTRACT OF USE
FOR WAGONS (GCU)**

**MINIMUM CONDITION AND MEASURES TO RESTORE FITNESS TO RUN
OF WAGONS**

TABLE OF CONTENT

A. CORRECTIVE MAINTENANCE

0. Principle
1. Running gear
2. Suspension
3. Brake
4. Wagon underframe and bogies
5. Buffing and draw gear
6. Vehicle body and accessories

B. HANDLING OF WAGONS AFTER AN INCIDENT

0. Principle
1. Derailment
2. Exceptional impacts
3. Overloading and exceeded concentrated loads
4. Flooding
5. Contact with energised catenary

Annex 1 – Signs indicating out-of-roundness on wheels

Annex 2 – Diagram of the Y25 bogie suspension

Annex 3 – European Visual Inspection Catalogue (EVIC) for axles

Annex 4 – Composite brake blocks: when to replace and not to replace

Annex 5 – Verification and handling of grease/oil deposits on wheels and axle boxes

Annex 6 – Coding of interventions

INTRODUCTION

Appendix 10 is intended for use by staff in workshops¹⁾ and collates in a single text all the provisions governing the minimum condition for parts (in accordance with the criteria set at international level) on leaving the workshop.

It comprises two chapters.

Chapter A (Corrective Maintenance) is structured in the same way as Annex 1 to Appendix 9 (Catalogue of Irregularities). This structure is as follows:

- Modules with measures to restore the fitness to run
- Minimum condition and limit values for dimensions
- Indications – Accepted and prohibited practices

From 1 January 2024, the text passages on the minimum condition and limit values in Chapter A will gradually be replaced by so-called modules. Modules describe a package of works (measures) to be carried out. Until all modules are fully included, both the modules and the previous text passages are listed side by side in Chapter A. Modules and text passages do not contradict each other. Modules are mandatory to implement.

The measures to restore the fitness to run are composed of:

- Technical requirements: special conditions that need to be in place in the workshop, in order to carry out maintenance operations (for example, pits, measuring tracks, torque wrenches).
- Organisational preparations: organisational measures e.g.: procuring materials, communicating with the keeper beforehand, etc. in order to carry out the maintenance operations.
- Work task: Describing the technical maintenance operations to be carried out on the vehicle or component.
- Technical target state: written descriptions of the individual steps, criteria to be met/limit values.
- Additional notes: references to other parts of the GCU esp. Appendix 10, information regarding the carrying out of individual steps, and safety-related information, where necessary.
- Documentation: special requirements for documenting the maintenance operations carried out; The documentation of the performed maintenance operations shall be done by naming the number of the measure to restore the fitness to run.

The following table describes the modules with measures required to restore fitness to run, depending on the damage codes:

Damage code Appendix 9:	Measures to restore the fitness to run
1. running gear	
1.1.1 Thickness of tyred wheel less than 35 mm on wagons suitable for running at 120 km/h or 30 mm on other wagons	M01.001: Wheelset removal/installation
1.1.2 Tyred wheel broken, cracked lengthways or crossways	M01.001: Wheelset removal/installation
1.1.3 Tyred wheel loose, inspection marks inconsistent or unclear ring or tyre clip loose or appearance of rust between the tyre and the rim over more than one third of the circumference	M01.001: Wheelset removal/installation
1.1.4 Inspection marks on tyred wheel missing, not clearly discernible	M01.001: Wheelset removal/installation
1.1.5 Tyred wheel shifted sideways, tyre clip loose or visibly distorted	M01.001: Wheelset removal/installation
1.1.6 Damage to tyred wheel clip (cracked, broken, missing)	M01.001: Wheelset removal/installation
1.2.1 Groove marking the minimum thickness is no longer fully visible in cross-section	M01.001: Wheelset removal/installation
1.2.2 Thermal overload due to braking: obviously recent paint burns of 50 mm or more at connection between rim and wheel plate (cracks or shelling on paint), traces of rust on rim (plate not painted), fusion of brake blocks, deterioration of wheel tread with build-up of metal (see also no. 1.3.4), uneven blueish appearance on rim due to the effect of thermal overload	M01.003: Handling of wagons after signs of thermal overload of wheelsets

Damage code Appendix 9:	Measures to restore the fitness to run
1.2.2.2 Thermal overload due to braking with gauge widening of the inner faces	M01.001: Wheelset removal/installation
1.3.1.2 Width of tyre or corresponding part of solid wheel > 140 mm < 133 mm, presence of a projection	M01.001: Wheelset removal/installation
1.3.2 Tread of tyre or corresponding part of solid wheel crushed in places, uneven contact surfaces or irregular protrusions on the wheel rim.	M01.001: Wheelset removal/installation
1.3.3.1 Wheel flat longer than 60 mm (wheel $\varnothing > 840$ mm)	M01.001: Wheelset removal/installation
1.3.3.2 Wheel flat longer than 40 mm (wheel $\varnothing 630$ mm < d ≤ 840 mm)	M01.001: Wheelset removal/installation
1.3.3.3 Wheel flat longer than 35 mm (wheel $\varnothing \leq 630$ mm)	M01.001: Wheelset removal/installation
1.3.4.1 Metal build-up over a length of > 60 mm or ≥ 1 mm thick (wheel $\varnothing > 840$ mm)	M01.001: Wheelset removal/installation
1.3.4.3 Metal build up over a length of > 40 mm or ≥ 1 mm thick (wheel \varnothing : 630 mm < d ≤ 840 mm)	M01.001: Wheelset removal/installation
1.3.4.5 Metal build up over a length of >35 mm and ≥ 1 mm thick (wheel $\varnothing \leq 630$ mm)	M01.001: Wheelset removal/installation
1.3.5.1 Cavity, shelling or flaking (wheel $\varnothing > 840$ mm, length > 60 mm)	M01.001: Wheelset removal/installation
1.3.5.2 Cavity, shelling or flaking (wheel \varnothing : 630 mm < d ≤ 840 mm, length > 40 mm)	M01.001: Wheelset removal/installation
1.3.5.3 Cavity, shelling or flaking (wheel $\varnothing \leq 630$ mm, length > 35 mm)	M01.001: Wheelset removal/installation
1.3.6.1 Cracks at the interface between the wheel tread and the front edge	M01.001: Wheelset removal/installation
1.3.6.4 Cracks on the tread - isolated cracks: with characteristics of thermal overload	M01.001: Wheelset removal/installation
1.3.7 Deposits of paint, oil or lubricants on wheel tread edge, except for control marks (4 paint marks positioned 90° apart)	M01.005: Cleaning the faces of the tyres or rims
1.3.8.2 Grooves with sharp edges ≥ 1 mm deep	M01.001: Wheelset removal/installation
1.3.8.3 Furrows and false flanges > 2 mm deep	M01.001: Wheelset removal/installation
1.4.1 Height of flange Sh greater than 36 mm (wagon with LL brake blocks and permissible speed greater than 100 km/h) and height of wheel flange Sh greater than 32 mm: hollow on wheel tread	M01.001: Wheelset removal/installation
1.4.2 Flange thickness S _d < 22 mm on wheel $\varnothing > 840$ mm or S _d < 25 mm on wheel \varnothing : 760 mm \leq d ≤ 840 mm or S _d < 27.5 mm on wheel $\varnothing < 760$ mm. For wagons with LL or K brake blocks, S _d > 33 mm on wheel $\varnothing > 330$ mm; worn flange	M01.001: Wheelset removal/installation
1.4.3 Wear of flange guide faces qR ≤ 6.5 mm or sharp flange	M01.001: Wheelset removal/installation
1.4.4 Burrs or sharp edges on guide face at a distance h > 2 mm from maximum height of flange (see also Annex 4)	M01.001: Wheelset removal/installation
1.5.1 Damage to solid wheel centre or wheel hub (cracked, defect repaired by welding)	M01.001: Wheelset removal/installation
1.5.2 Damage to tyred wheel centre, tyre clip, tyre (cracked, broken or defect repaired by welding)	M01.001: Wheelset removal/installation
1.6.1 Damage to axle (cracked, deformed (see also 1.7.1), defect repaired by welding, sharp edge, worn to a depth of more than 1 mm)	M01.001: Wheelset removal/installation
1.7.1 Clearance between internal faces of wheelset non-compliant with limit values, signs of derailment, signs of movement of wheel on axle, heating (solid wheel) in fillet zone between web and rim/tyre	M01.001: Wheelset removal/installation
1.8.1.1 Housing axle box not watertight, defect allowing water or dust to enter: cracked or broken housing or missing plug (the loss of the protective cap of the centring cone is permissible), except housing types without cover	M01.001: Wheelset removal/installation

Damage code Appendix 9:	Measures to restore the fitness to run
1.8.2 Axle box guides no longer able to guide the axle (guide broken or axle box in abnormal position) 1.8.3.1 Hot box housing too hot to touch with back of hand, traces of rust 1.8.3.2 Confirmation by the RU of box over-heating during transport 1.8.4 Hard manganese wear plate on axle box of Y bogie or derivative designs displaced or missing	M01.001: Wheelset removal/installation M01.001: Wheelset removal/installation M01.001: Wheelset removal/installation M01.001: Wheelset removal/installation
2. Suspension	
2.1.1 Spring leaves displaced by more than 10 mm with respect to buckle, shiny marks near buckle 2.1.2 Main leaf fractured or with visible crack 2.1.3 Part of a fractured suspension spring leaf missing 2.1.4.1 Fracture (but without any part missing) of intermediate suspension spring leaf at a distance from the centre of the spring of less than 1/4 of leaf length 2.1.6 Buckle loose (fracture or crack in buckle, key missing or ineffective) or signs of loosening of leaves 2.2.1.1 Main or intermediate spring leaf visible crack or break 2.2.1.2 Main or intermediate spring leaf buckle broken, two leaves touching over 50% of their length 2.2.2.1 Leaf parabolic spring displaced lengthways > 10 mm 2.2.3 Buckle damaged or loose (buckle fractured, cracked or lug of the lower key cracked or weld seam of upper key fractured or cracked) 2.4.1 Boss of buckle out of position, abnormal position of axle box 2.4.3 Link pin displaced, missing, not secured	M02.001: Leaf-spring suspension removal/installation M02.001: Leaf-spring suspension removal/installation M02.001: Leaf-spring suspension removal/installation M02.001: Leaf-spring suspension removal/installation M02.001: Leaf-spring suspension removal/installation M02.001: Leaf-spring suspension removal/installation M02.001: Leaf-spring suspension removal/installation M02.001: Leaf-spring suspension removal/installation M02.001: Leaf-spring suspension removal/installation M02.001: Leaf-spring suspension removal/installation M02.002: Insert buckle boss M02.003: Suspension links removal/installation
3. Brake	
3.2.4.2 Defective brake disc fixing on the axle pin 3.2.4.4 Crack in cross section on brake disc	M01.001: Wheelset removal/installation M01.001: Wheelset removal/installation
4. Wagon underframe and bogies	
4.1.1 Wagon underframe warped vertically or horizontally (buffer height out of tolerance range, visible distortion) 4.1.2 Solebar, headstock stressed by coupler or intermediate crossbar exhibiting a fracture or crack 4.2.1 Axle guard distorted, safety hazard 4.2.2 Axle guard broken, abnormal position 4.2.3.1 Axle guard, fastening loose 4.2.4.1 Axle guard crack running over more than ¼ of horizontal cross-section 4.2.4.3 Axle guard crack close to or running towards a fastening point, regardless of length of crack 4.3.1 Axle guard tie bar missing, broken, visibly distorted, loose 4.4.1.2 More than one axle guard check plate missing per axle (bogie wagon) 4.4.1.3 One axle guard check plate missing (axle wagon) 4.4.2 Hard manganese wear plate on Y bogies or derivative designs displaced or missing 4.5.1 Suspension bracket (axle wagon) loose, cracked, broken or distorted (space between bracket and solebar; half or more of the fastening elements missing or broken)	M00.001: Keeper instructions to be obtained M00.001: Keeper instructions to be obtained M00.001: Keeper instructions to be obtained M00.001: Keeper instructions to be obtained M00.001: Keeper instructions to be obtained M00.001: Keeper instructions to be obtained M00.001: Keeper instructions to be obtained M04.001: Axle-guard tie removal/assembly M00.001: Keeper instructions to be obtained M00.001: Keeper instructions to be obtained M00.001: Keeper instructions to be obtained M00.001: Keeper instructions to be obtained

Damage code Appendix 9:	Measures to restore the fitness to run
4.6.1 Connection between bogie and underframe defective	M00.001: Keeper instructions to be obtained
4.7.1 Bogie frame component cracked or visibly distorted	M00.001: Keeper instructions to be obtained
4.7.2 Bogie frame component broken	M00.001: Keeper instructions to be obtained
5. Buffing and draw gear	
5.1.2 Buffer height exceeding tolerance range $h < 940$ mm (980 mm in the case of coaches), $h > 1065$ mm or significant difference in buffer height at coupled wagon ends	M00.001: Keeper instructions to be obtained
5.9.1 Sliding element (long-stroke damper) not in mid-position with respect to wagon underframe, the two headstocks are at different distances from wagon body	M00.001: Keeper instructions to be obtained
6. Vehicle body and accessories	
reserved	reserved

Chapter B sets out provisions for dealing with wagons after specific incidents which have caused, or potentially caused, damage.

The markings and signs that wagons must carry are given in Appendix 11. Appendix 10 only covers those markings that can lead to a wagon being withdrawn from service under the terms of Appendix 9.

¹⁾ A workshop is a body comprising the management, staff, installations and tools necessary for the execution of corrective and preventive maintenance on wagons and/or their component parts. Mobile units are considered to be workshops if they operate under the authority of a maintenance workshop or if they operate independently and meet the aforementioned conditions.

A. CORRECTIVE MAINTENANCE

0. Principle

The keeper must ensure that wagons are restored to a condition making them fit for normal service in terms of load safety and conservation.

To do so, he has recourse to the services of an Entity in Charge of Maintenance, one of whose responsibilities (as set out in EU Regulation 2019/779 and the corresponding COTIF rules) is to define a preventive maintenance plan and instructions, which the keeper must apply.

Wagon keepers, customers of repair work and workshops must all ensure that wagons are free from defects that are liable to lead to the vehicle being removed from service again, based on the provisions of Appendix 9 on the instructions issued for repairs to be carried out and Appendix 10, Chapter A (and where appropriate also Chapter B) on the actual execution of repair work.

If a RU has marked damages on a freight wagon to be repaired in accordance with Appendix 9, Annex 11 of the GCU before the wagon is brought into a workshop, these markings must be removed by the workshop before the wagon is handed over to an RU. Any marking on the wagon or its parts regarding non-repaired damages must remain.

Chapter A of Appendix 10 contains criteria and guidance to be applied by workshops to remove irregularities as understood by Appendix 9. The measures carried out and documented under Appendix 9 (e.g., Annex 12) do not need to be repeated under Appendix 10. For measurements carried out under Appendix 10, suitable and calibrated measuring instruments should be used, following the provisions set out in EN ISO 10012 on processes and measuring instruments.

It is not necessary to apply the whole of Chapter A of Appendix 10 each time a wagon is sent to a workshop, only those provisions relating to the damage that is to be repaired.

For any repair works the workshop must ensure that no other parts or components of the wagon and their coating/painting are damaged by these operations. Appropriate measures (e.g. by protecting parts) must be taken.

Loading residues in the wagon, which hinder repair works, can be removed by the workshop.

Irrespective of the reason for a wagon's withdrawal from service, compliance with those provisions that are marked with an asterisk (*) is required systematically whenever a wagon is sent to the workshop.

If the workshop is not in a position to restore the wagon to the minimum specified condition, the vehicle must be handled in accordance with the keeper's instructions (procedure as per Appendix 9).

Modules with measures to restore the fitness to run

M00.001 Keeper instructions to be obtained

Technical requirements:	-
Organisational preparations:	-
No.	Work tasks, technical target state and additional notes
1.	Compile information on damage
2.	<input checked="" type="checkbox"/> Contact the keeper regarding further action and, if necessary, request replacement parts with → Form H in accordance with Appendix 7

1. Running gear

Modules with measures to restore the fitness to run

M01.001 Wheelset removal/installation

Technical requirements:	Wheelset lowering and/or lifting equipment
Organisational preparations:	<input checked="" type="checkbox"/> If necessary, request wheelset from the keeper with →Form H ^R in accordance with Appendix 7
No.	Work tasks, technical target state and additional notes
1.	Prepare wheelset removal, taking into account →1.36: <ul style="list-style-type: none"> loosen axle-guard tie or T-lifting guard increase brake block clearance for unhindered removal of the wheelset remove parts obstructing wheelset removal <i>Additional notes: secure the suspension springs against tipping, for the removal of the axle-guard tie →M04.001</i>
2.	Remove wheelset: <ul style="list-style-type: none"> One-sided lifting of the wagon is only permitted with the appropriate signs When lifting vehicles, the permissible ramp angles must be observed Lifting at the buffers is not permitted Bogies must not hang from the bogie pin Hydraulic and pneumatic hoses as well as electrical cables must not be damaged or kinked
3.	Examine brake blocks in accordance with →3.7 and →3.8
4.	If the axle becomes damaged through rubbing, rectify cause →M03.004 (in creation)
5.	Install wheelset →1.21
6.	Remount disassembled parts with suitable locking screws and nuts according to the previously attached connections <i>Additional notes: →M04.001 when attaching the axle-guard tie →M04.001</i>
7.	Measure buffer height →M05.002 (in creation)
8.	Carry out a brake function test →M03.001

*M01.002: EVIC Inspection for axles

Technical requirements:	Working pit or lifting device; requirements in accordance with →Annex 3 point 3.1 met
Organisational preparations:	-
No.	Work tasks, technical target state and additional notes
1.	Inspection in accordance with →Annex 3
2.	If case A in accordance with EVIC catalogue, replace wheelset →M01.001

M01.003: Handling of wagons after signs of thermal overload of wheelsets

Technical requirements:	-
Organisational preparations:	-
No.	Work tasks, technical target state and additional notes
1.	Check the brake to determine the cause of the damage →M03.002 (in creation)
2.	If the brake is defective: <input checked="" type="checkbox"/> inform keeper and switch off the brake
3.	Replace wheelset →M01.001
4.	Check the brake blocks in accordance with →3.7 or 3.8 <i>Additional notes: where appropriate, replace the brake blocks →M03.003 (in creation)</i>
5.	Check the operability of the brake if the brake is not switched off →M03.001

M01.005: Clean the faces of the tyres or rims

Technical requirements:	-
Organisational preparations:	-
No.	Work tasks, technical target state and additional notes
1.	Clean the faces of the tyres or rims: <ul style="list-style-type: none"> • No damage to the wheel centre • No damage to the coating of the wheel centre

Minimum condition and limit values for dimensions**Wheelsets**

- 1.1 The following four conditions concern the distance between the wheels, measured close to rail level, with the wagon empty or loaded, and the thickness of the flanges. They must all be met concurrently:
- 1.1.1 Distance between the active faces of the wheels, measured 10 mm down from the measuring circles:
- maximum 1426 mm,
 - for wheels with a diameter of greater than 840 mm¹⁾ at least:
 - 1418 mm for the wheelsets of 2-axle wagons with double-link suspension, suitable for running at 100 km/h with a 22.5 t axle-load and a wheelbase of 8 m or more,
 - 1410 mm for the wheelsets of other wagons,
 - at least 1415 mm for wheels with a diameter of less than or equal 840 mm.
- 1.1.2 Distance between the inner faces of tyres or rims of monobloc wheels:
- maximum 1363 mm¹⁾;
 - minimum 1357 mm for wheels with a diameter of greater than 840 mm¹⁾,
 - minimum 1359 mm for wheels with a diameter of less than or equal 840 mm¹⁾.
- The difference between the distances measured for the relevant axles must be ≤ 2 mm ($E_{\max} - E_{\min} \leq 2$ mm). Measurements must be taken in accordance with 1.17.
- 1.1.3 Wheels must show no signs of displacement along the axle.
- 1.1.4 Thickness of the flange of one wheel, measured 10 mm below the running circle:
- minimum 22 mm for wheels of diameter greater than 840 mm,
 - minimum 25 mm for wheels of diameter less than or equal to 840 mm but greater than 760 mm,
 - minimum 27.5 mm for wheels of diameter less than or equal 760 mm.
- Flange thickness must not exceed 33 mm, irrespective of the diameter of the wheel.
These values do not apply to wheelsets with tapered flanges (e.g. certain bogies with three or more axles).
- 1.2 The diameter of the wheel running circle must not be less than:
- 840 mm for a nominal diameter of 920 to 1000 mm,
 - 760 mm for a nominal diameter of 840 mm,
 - 680 mm for a nominal diameter of 760 mm,
 - 630 mm for a nominal diameter of 680 mm.
- 1.3 The width of the tyre or rim of monobloc wheels must be:
- maximum 140 mm²⁾,
 - minimum 133 mm.

¹⁾ These rules also apply to the intermediate axles of wagons with a 3-axle articulated underframe, but not to the intermediate axles of vehicles other than bogie wagons, nor to the intermediate axles of the bogies themselves.

²⁾ Including the projection formed by the outer edge of the running tread.

- 1.4 The height of the wheel flanges must be:
- minimum 27.5 mm for wheels of a diameter greater than 760 mm,
 - minimum 29.5 mm for wheels of a diameter greater than 630 mm, but less than or equal to 760 mm and
 - minimum 31.5 mm for wheels of a diameter less than or equal to 630 mm.
- The height of the wheel flanges must be no more than 36 mm.
When using LL soles in wagons with a maximum speed greater than 100 km / h and a wheel diameter **greater than 760 mm**, the limit value for the height of the flange from 27.5 to 32.0 mm must be respected.
These values do not apply to wheelsets with tapered flanges (e.g., certain bogies with three or more axles).
- 1.5 The wheel flange, measured with a gauge, must have a qR value that is always greater than 6.5 mm, with no sharp edges or burrs on the outside profile of the flange, at a distance of more than 2 mm from the upper edge (Appendix 9, Annex 4).
- 1.6.1 The wheel tread must not:
- be partly crushed,
 - display wheel flats, shelling, exfoliation or metal build-up:
 - over 60 mm in length for wheels of diameter > 840 mm and axle load ≤ 22.5 t (maximum load limit D or less);
 - over 50 mm in length (maximum load limit E) for wheels of diameter > 840 mm and axle load > 22.5 t,
 - over 40 mm in length for wheels of diameter ≤ 840 mm and > 630 mm,
 - over 30 mm in length for wheels of diameter ≤ 630 mm.
 - have cracks at the transition between the tread and the outer face or on the flange top,
 - display any hollowing or “false flange” deeper than 2 mm or any sharp-edged grooves.
 - show isolated transverse cracks on the tread of wheels with tread brakes (superficial thermal lattice-type cracking – “toad skin” cracking – is permitted).
- 1.6.2 * Wheelsets fitted with LL blocks must be inspected and dealt with as follows:
- Inspect running surfaces in accordance with 1.6.1.
 - Visual inspection of the wheels in accordance with the criteria for thermal overload as set out in 1.18.
- 1.7 The lateral face of the wheel and the inner part of the rim or tyre (active face) must not be gouged or marked with sharp-angled notches.
- 1.8 For monobloc wheels, the wear limit of the tyres must be indicated by the bottom of a circular groove concentric with the wheel and traced on the outside surface¹⁾. This groove must always remain fully visible. It may however be partially obscured by dirt providing this does not detract from the possibility of assessing the wear state of the wheel.
- 1.9 The thickness of the wheel tyre measured in the plane of the running circle – defined as the circle where a vertical plane 70 mm from the inner surface of the tyre intersects the wheel tread – must be at least:
- for wagons authorised to run at 120 km/h
(wagons marked “SS” or “**”) 35 mm
 - for other wagons²⁾ 30 mm
- 1.10 On a wheel with tyre:
- 1.10.1 The tyre must not be loose,
A tyre is considered loose if at least one of the following conditions is met:
- the tyre has been displaced by rotation on the rim in the plane of the running circle (visible from the fact that the check marks on the tyre and those on the wheel rim are no longer aligned),
 - dull sound when struck,
 - loose tyre clip,
 - presence of rust between the tyre and the rim over more than $\frac{1}{3}$ of the circumference.

¹⁾ If exceptionally there are two grooves on a wheel, the outer groove shall indicate the minimum thickness.

²⁾ Including wagons suitable for 120 km/h only when empty.

- 1.10.2 The tyre must show no signs of sideways movement (a tyre can only move sideways if the tyre clip is missing or has become loose, broken or clearly deformed),
- 1.10.3 The tyre clip must not be cracked. When the tyre clip is held in place with a wedge, the wedge must not be missing,
- 1.10.4 Tyres must not be cracked or fissured in the transverse or longitudinal directions.
- 1.11 The wheel hub must not be cracked.
- 1.12 The rim of a spoked wheel must not be broken across.
- 1.13 None of the spokes of a wheel may be broken or cracked.
- 1.14 A solid or monobloc wheel must not show:
- any defects repaired by welding and
 - any cracks.
- Minor defects in the wheel body resulting from the casting process are acceptable.
- 1.15.1 Axles must not:
- show any cracks or any defects repaired by welding,
 - be warped,
 - have any part worn by friction showing sharp edges (sharp-edged notches),
 - show any kind of wear by friction exceeding 1 mm in depth.
- Brake rods or other parts must not rub on the axles.
- 1.15.2 * The prescriptions of Annex 3 are to be applied.
- 1.16 * Each time the wagon is in the workshop, the wheel+tyre assembly of all wagons fitted with tyres must be checked. The dates on which this verification and the one before it takes place are entered in the maintenance plate specified in Appendix 11, point 7.5 against the initials of the RU and workshops that conducted the check in question.
- 1.17 If a check is required on the distance between the inner faces of the tyres or rims of monobloc wheels, then this distance shall be measured at rail level, with an appropriate measuring device, in at least three points on the wheel, at 120° intervals.
- 1.18 Monobloc wheels may not display marks of thermal overload caused by the brake:
- clearly burnt paint at the connection between rim and wheel plate (paint cracked/peeled),
 - traces of rust at connection between rim and wheel plate,
 - fusion of brake blocks,
 - deterioration of wheel tread with build-up of metal (see number 1.6.1 too),
 - rim bluish coloured (not uniform) due to overheating,
 - protruding (flanging) brake blocks.
- If thermal overload is suspected, a brake test must be performed in accordance with UIC Leaflet 543-1 and the keeper must be consulted in order to obtain instructions. If the keeper does not provide instructions, the wheelsets concerned must be replaced using Form H^R.
- Wheels that are able to withstand high thermal stresses and which are marked on the cover of the axle-box casing with an interrupted vertical white line (Appendix 11, point 6.1) are exempt from the measures listed above.
- The burnt paint must not be painted over unless agreement for the keeper is guaranteed.
- 1.19 Wheels shall be tested for out-of-roundness when
- at least two signs of out-of-roundness and wheel tread defects as defined in Appendix 10, annex 1 are detected on a wagon wheel or its immediate environment,

- on the wheels of the axle in question, if there are no signs on the second axle,
- on the wheels of both axles, if there is at least one sign on the second axle,
- they are indicated “Substantial irregular crushing on the edge of the tyre”, as defined in Appendix 10, annex 1, picture 9 (indication of a particular flat point), irrespective of the presence of any other indication.

In this respect a bogie is to be considered as an axle wagon. The degree of wheel out-of-roundness must not exceed 0.6 mm.

Axle-boxes

- 1.20 Axle-boxes must not be damaged to the point of no longer being able to hold their lubricant or of allowing dust and water infiltration.
- 1.21 The sides of the axle-box must cover the guiding surface of the axle guard or of the corresponding bogie parts in all positions of the box, with an overlap of at least 5 mm.

Indications – Accepted and prohibited practices

- 1.22 Axles must not be repaired by welding.
- 1.23 The side faces of the tyres or rims of monobloc wheels must not be painted or covered over with oily or greasy substances, with the exception of the four painted control markings at 90° intervals used to identify tired wheels (Appendix 11, point 6.2).
- 1.24 Brake rods and other parts must not rub against the axles. If this fault cannot be corrected, the parts in question must be removed or suspended so as to prevent contact. The brake must then be isolated and fitted with labels R1 and K (as per Appendix 9).
- 1.25 Sharp edges on a flange may be removed on the lathe or by grinding.
- Any flats or build-up of metal on the running tread may be removed on the lathe with the keeper's agreement.
- 1.26 When an axle is replaced, a wheelset or wheelsets with tired wheels may not be fitted to a wagon equipped with monobloc wheels.
- Tank wagons and wagons loaded with tank containers for the carriage of Class 2 RID products must be fitted with monobloc wheels.
- 1.27 To position the wheelsets on a lathe, the workshop of the user RU may only remove the axle-box covers if they are not fitted with centering holes. All other work on axle-boxes is reserved for the keeper alone.
- 1.28 When reprofiling monobloc wheels with the authorisation¹⁾ of the keeper:
- identify any cracks along the edge of the wheel tread and any sharp-edged dents on the flange and remove by reprofiling,
 - remove any severe radial marks left by the lathe clamping jaws.
- Wheels with an out-of-roundness of ≥ 0.6 mm (see point 1.19) may not be reprofiled. They must be removed and returned to the keeper, suitably marked.
- 1.29 Existing wheelsets fitted with monobloc wheels of steel grades R2, R3, R8 and R9 must be tested by the keeper to check for the absence of cracking and lathe clamp jaw marks. After the test a triangular metal plate embossed with the steel grade is fixed to one of the bolts of the axle-box cover.
- 1.30 Wagons with load-proportional tread brakes for running under SS conditions may not be fitted with monobloc wheels of steel grades R2, R3, R8 or R9.

If thermal overloading is suspected, the provisions of point 1.18 shall apply.

¹⁾ This authorisation may be permanent or issued on a case-by-case basis.

- 1.31 Oil seepage between the axle and wheel hub does not constitute absolute proof of loosening. Displacement must be shown to have occurred.
- 1.32 If there is any sign or suspicion of a hot axle-box, the axle must be replaced.
- 1.33 Bearings shall only be lubricated by the keeper.
- 1.34 No repairs may be carried out on axle-boxes.
- 1.35 If a replacement axle is requested using Form H^R (see Appendix 7), the diameters of the running circles of all the axles on the wagon must be measured and shown on the Form H^R (column B) so that the keeper can supply an axle with a running circle whose diameter is within the difference range permitted by the applicable regulations.
- If an axle is replaced without making use of the Form H^R procedure and with no specific indication from the keeper, the difference in the diameters of the running circles must not be greater than:
- 10 mm between the two axles of a bogie,
 - 20 mm for axle wagons.
- 1.36 If the workshop identifies connections between the wheelset and the underframe or the bogie (electrical, hydraulic, pneumatic, etc..., other than grounding cables), it cannot disconnect them without having received instructions for dismantling or assembly from the keeper.
- 1.37 The following checks must be performed after replacing wheelsets:
- Check brake-rigging adjustment,
 - Check that the slack adjuster is working,
 - Finally, perform a functional check by applying and disengaging the brake.

2. Suspension

Modules with measures to restore the fitness to run

M02.001: Leaf-spring suspension removal/installation

Technical requirements:	Wheelset lowering and lifting equipment
Organisational preparations:	<input checked="" type="checkbox"/> If necessary, request suspension spring from the keeper with → Form H in accordance with Appendix 7
No.	Work tasks, technical target state and additional notes
1.	Prepare suspension spring removal: <ul style="list-style-type: none"> Lift the wagon to ease the load on the spring Lifting at the buffer is not permitted
2.	Remove suspension spring: <ul style="list-style-type: none"> Remove suspension spring shafts
3.	Install suspension spring: <ul style="list-style-type: none"> Fit a securely seated buckle boss/axle-box housing Suspension spring shaft lubricated Pay attention to installation of the suspension bearings Fold down split pin properly (split pin half 30° open) <i>Additional notes: For vehicles with a rigid underframe (XX) the suspension spring are to be exchanged on both sides of the wheelset</i>
4.	Minimum leaf clearance in accordance with → 2.5.1

M02.002: Insert buckle boss

Technical requirements:	Lifting equipment
Organisational preparations:	-
No.	Work tasks, technical target state and additional notes
1.	Prepare buckle boss: <ul style="list-style-type: none"> Lift the wagon to ease the load on the spring Lifting at the buffer is not permitted
2.	Insert buckle boss: <ul style="list-style-type: none"> Fit a securely seated buckle boss/axle-box housing
3.	Minimum leaf clearance in accordance with → 2.5.1

M02.003 Suspension links removal/installation

Technical requirements:	Wheelset lowering and lifting equipment
Organisational preparations:	<input checked="" type="checkbox"/> If necessary, request suspension links from the keeper with → Form H in accordance with Appendix 7
No.	Work tasks, technical target state and additional notes
1.	Remove suspension links: <ul style="list-style-type: none"> Suspension spring shaft removed
2.	Install suspension links: <ul style="list-style-type: none"> Clean suspension spring bore hole Suspension spring shaft lubricated Installation of the suspension bearings observed Suspension link free to move after installation

Minimum condition and limit values for dimensions

- 2.1 The leaves of a suspension spring must not become longitudinally displaced by more than 10 mm in relation to the buckle.
- 2.2 None of the leaves must be missing, broken or cracked. This provision applies both to parabolic springs and trapezoidal springs.
- 2.3 No helical spring must be broken.
- 2.4 None of the parts necessary for fastening the springs must be missing or broken. None of the spring buckles must be loose.
- 2.5.1 On wagons fitted with leaf spring suspensions, the distance between the buckle of the suspension spring and any parts of the vehicle body, underframe or bogie frame which may be liable to come into contact with it must be at least 15 mm.
- 2.5.2 In respect of the suspension of bogie Y25 and its by-products, the distance between the axle-box housing and the bogie frame must be at least 8 mm.
- 2.6 There must be no recent traces of contact between:
- the spring buckle or other parts of the suspension and the wagon underframe or bogie,
 - the wheels and the body or underframe.
- Once the causes have been remedied, the traces of contact shall be painted over.
- 2.7 The boss of the leaf spring buckle must be properly engaged in its housing (axle-box case or plug). The axle-box case must not be in an abnormal position (twist) as a result.
- 2.8 The component parts of the elastic suspension (rings, rods, intermediate bearings, suspension pins) must not be displaced, missing or broken. The suspension pins must be properly secured.

Indications – Accepted and prohibited practices

- 2.9 The minimum distance between the buckle of the suspension spring and any parts of the vehicle body, underframe or bogie frame which may be liable to come into contact with it may not be restored by:
- placing sheet metal shims between the suspension brackets or bearings and the links, even if these sheets are welded,
 - building up the suspension brackets or bearings by welding.
- 2.10 In the event of damage to the suspension spring of a wagon with a rigid underframe (marked as shown in Appendix 11, point 7.4), both springs of the same axle must be replaced by two others with equivalent deflections. The request for spare parts using Form H (see Appendix 7) must therefore specify that the springs are to be used on a wagon with a rigid underframe.
- For springs with progressive stiffness, it is not necessary to replace both springs. When requesting springs of this kind, the type of spring must be mentioned specifically on Form H.
- 2.11 Repairing suspension springs by welding is prohibited.
- 2.12 Standard parabolic suspension springs for 22 or 22.5 tonne axle-loads can be freely inter- changed in the event of damage.

3. Brake

Modules with measures to restore the fitness to run

M03.001 Brake function test

Technical requirements:	Air available for carrying out the function test
Organisational preparations:	-
No.	Work tasks, technical target state and additional notes
1.	Check adjustment of the brake rigging: <ul style="list-style-type: none"> Take wheel diameter and brake block thickness into account
2.	Carry out a function test by applying and disengaging the brake multiple times: <ul style="list-style-type: none"> Slack adjuster must be able to readjust

Minimum condition and limit values for dimensions

Compressed air brakes

- 3.1 On wagons with compressed-air brakes, the handle of the brake isolating valve must be turned vertically downwards when the brake is operational. It must be possible to isolate the brake by a 90° turn on the handle at the most. This handle must satisfy the conditions set out in Appendix 9, annex 10.
- 3.2 The function of the brake position changeover controls must be easily identifiable in accordance with the stipulations of Appendix 11, point 4.3.
- 3.3 The main brake pipe must be in proper working order, to ensure a continuous air supply along the train.

Brake blocks, shoes, disc brakes and brake rigging

- 3.4 The disc brake indicator device must clearly display the “brake on” and “brake released” positions.
- 3.5 None of the brake rigging safety stirrups must be broken, loose or missing.
- 3.6 If wagons have protruding (flanging) brake blocks, it is necessary to eliminate the cause of the protrusion after consultation with the keeper and after he has given instructions. If it is not possible to remedy the cause the wagon must be dealt with in accordance with Appendix 9. A brake block shall be considered protruding if, when it is applied, its external face reaches the external face of the rim. In the event of protruding brake blocks, the wheels must be checked for signs of thermal overload as per point 1.18, Appendix 10.
- 3.7 Cast-iron brake blocks
- 3.7.1 Cast-iron brake blocks that are worn, broken or missing must be replaced.
- The minimum thickness of brake blocks, measured at the thinnest point as seen from the outside, must be 10 mm.
- Brake blocks
- with an incipient crack shall not be considered as broken,
 - shall be considered broken if they are only held in place by their metal reinforcement layer.
- 3.7.2 On double brake block holders (Bgu), when one of the cast-iron blocks is replaced, the other block must also be replaced in all cases.
- 3.8 Composite brake blocks
- 3.8.1 Composite brake blocks **are to be replaced** when the following defects/damage are observed:
- blocks are missing,
 - blocks are broken radially from the friction surface to the plate/edge of the plate (Annex 4, picture 7),
 - friction material shows visible signs of shelling over more than ¼ of the length of the block,

- blocks display metal inclusions in the friction surface (Annex 4, picture 1),
- friction material has become detached from plate over a length of > 25 mm (Annex 4, picture 2),
- friction material has cracked parallel to the wheel circumference over a length of > 25 mm (Annex 4, picture 4),
- minimum thickness of the brake blocks, measured at the thinnest point as seen from the outside, is less than 10 mm.

3.8.2 Composite brake blocks **are not to be replaced if:**

- they are partially cracked or cracked straight across at the designated breaking-point (Annex 4, picture 3),
- there is incipient radial cracking in the block material (Annex 4, picture 6),
- there are indications of heavy thermal stress such as “white film” on the surface of the contact area and down to a depth of around 10 mm (Annex 4, picture 8),
- there is a branched thermal crack pattern, mainly axial, and a carbonised layer (Annex 4, picture 9).

3.8.3 Where several types of brake block are approved and marked as suitable for use on a wagon, all the brake blocks around a single wheelset must be of the same type.

3.8.4 On double brake block holders (Bgu), when one of the composite brake blocks is replaced, the other block must also be replaced in all cases.

Brake hose couplings

3.9 All wagons must be fitted with brake hose semi-couplings. Wagons with two brake coupling connections at each end for the same main brake pipe must also have two brake semi-couplings at each end.

3.10 Brake semi-couplings must not be defective (not airtight).

3.11 No part of the brake coupling system (whether connected or disconnected) must hang down within 140 mm of the top of the rails.

3.12 The stop cocks must be operable and function correctly. Each air stop cock must be fitted with a stop device in its extreme position that functions correctly.

Indications – Accepted and prohibited practices

3.13 Damaged or loose brake parts that could constitute a safety hazard or cause other damage must be removed or securely fastened. Damage of this kind should be examined in conjunction with point 1.19. In this case, the compressed air brake must be isolated, and the wagon fitted with labels R1 and K.

3.14 Work on the pneumatic parts of the brake system (distributors, relay valves, load-weight valves, brake cylinders) and their replacement by workshops shall not be authorised without the agreement of the wagon keeper.

3.15 Wagons with platform-operated or ground-operated hand brakes / parking brakes that are inoperable must be repaired. Otherwise, they must be dealt with in accordance with Appendix 9.

3.16 Disc brake pads may be replaced exclusively by the keeper, who shall ensure that the brake is in correct working order without needing to be monitored by the userRU.

3.17 Missing or damaged brake semi-couplings must be replaced.

3.18 Safety stirrups may not be repaired by welding.

3.19 All brake tests in application of Appendix 12 of the GCU shall be carried out in accordance with UIC Leaflet 543-1 prior to any action being taken and the brake test sheet including the values measured communicated to the keeper and to the userRU.

3.20 Broken or missing brake release pulls are to be replaced.

3.21 The following checks must be performed after replacing brake blocks:

- Check brake-rigging adjustment,
- Check that the slack adjuster is working,
- Finally, perform a functional check by applying and disengaging the brake.

4. Wagon underframe and bogies

Modules with measures to restore the fitness to run

M04.001: Axle-guard tie removal/installation

Technical requirements:	Torque wrench
Organisational preparations:	<input checked="" type="checkbox"/> If necessary, request axle-guard tie from the keeper with → Form H in accordance with Appendix 7
No.	Work tasks, technical target state and additional notes
1.	Remove axle-guard tie
2.	Test the bore holes of the axle guard and axle guard tie: <ul style="list-style-type: none"> • Not deformed, worn out, knocked out • Properly fit of the bore hole and fitting screw
3.	Install axle-guard tie: <ul style="list-style-type: none"> • Fitting screws not worn • Threads not damaged • Tightening torque 180 Nm with screw connections M20 class 8.8 <i>Additional notes:</i> <input checked="" type="checkbox"/> ask the keeper for the torque for other type of screw connection.

Minimum condition and limit values for dimensions

Underframe

- 4.1 The underframe must not be visibly deformed or warped.
- 4.2 The flanges of solebars, headstocks and intermediate cross-bars subject to stress from the coupler must not have cracks (transverse tracks) starting at the edge of the flange and extending over more than half the flange width. Longitudinal cracks up to 150 mm are acceptable, except at the points where the suspension brackets are fixed to the solebars. At these points, longitudinal cracks between the flange and the web of the solebar must not exceed 100 mm in length.
- 4.3 Welded joints on underframe crossbars and solebars, and on axle guards and solebars, must not have cracks, nor must any cracks in these parts originate in the joints.
- 4.4 Reserved
- 4.5 Reserved
- 4.6 Wagons with inflammable floors, even if lined with a metal sheet underneath, must be fitted with spark arrestors above the braked wheels. Spark arrestor plates mounted directly beneath the floor are not acceptable.
- This stipulation also applies to flat wagons that have no floor or with a skeletal floor, intended for carrying containers or semi-trailers.
- The spark arrestor plates must not be dislodged or pierced through by rust.
- 4.7 Axle wagons carrying the sign specified in Appendix 11, point 2.10 must be fitted with special spark arrestors.
- 4.8 Axle guards must not be dislodged or broken. They may not have cracks over more than ¼ of their cross-section or that are extending towards or close to a fastening point.
- 4.9 No guide-pieces (wear liners) must be missing from the axle guards.
- 4.10 Axle-guard ties must not be missing or broken.
- 4.11 Suspension spring brackets must not be loose, broken, cracked or visibly deformed.

Bogies of all types

- 4.12 Welded joints on bogie frame crossbars and solebars must not be cracked, nor must any cracks in these parts originate in the welded joints. Solebars, crossbars and bolster swing- links must not have any cracks.
- 4.13 The friction surfaces of damping systems acting on the axle-box or bolster guides must not be lubricated.
- 4.14 No side bearers, side bearer parts or springs must be missing or broken.
- 4.15 The bogie must not be lying in an abnormal position in relation to the frame.
- 4.16 The centre casting must not be broken or loose.
- 4.17 The centre casting kingpin and its locking devices must not be missing, broken or loose.
- 4.18 No guide pieces (wear liners) may be missing.
- The total length of cracks in the weld beads of the wear liners may not exceed 50% of the total length of the welds.
- 4.19 The earth connections' connecting parts must be checked and fastened if necessary. Missing or damaged earth connections (straps or cables) and connecting parts must be re- placed. Connection points indicate that earth connections must be present.

Y 25 bogies and their derivatives (see Annex 2)

- 4.20 No tare springs must be cracked or broken. Damage of this kind should be examined in conjunction with point 1.19.
- 4.21 No load springs must be displaced or broken. Damage of this kind should be examined in conjunction with point 1.19.
- 4.22 All the tare springs of the bogie must coil in the same direction.
- 4.23 All the pairs of helical springs on a bogie (tare spring/load spring) must coil in opposite directions.
- 4.24 No outer or inner damper ring may be missing, broken or loose. No tappet must be missing (e.g., following a derailment).
- 4.25 No damper cover may come into contact with the bogie frame (faulty damper).
- 4.26 No lifting T must be missing or loose. Damage of this kind should be examined in conjunction with point 1.19.

Indications – Accepted and prohibited practices

- 4.27 Cracked steps must be replaced by the workshop of the user RU. Repairs involving welding are prohibited.
- 4.28 When the spark arrestor plates of a wagon are missing or damaged without the possibility of proper repairs being carried out, the brake must be isolated and the wagon dealt with in accordance with Appendix 9 (labelling).
- 4.29 Breakages, damage and cracks on solebars, intermediate crossbars, underframe headstocks (wagon or bogie) and welded joints must only be repaired by welding at a workshop selected by the keeper. However, the workshop of the user RU may, exceptionally, be authorised to carry out welding work for the sole purpose of repairing cracks or breakages on underframe profiles, to make it possible for an empty wagon to be returned home.

- 4.30 Wagons whose underframe is warped or deformed and which are not fit to run must be specially treated, in agreement with their keeper.
- 4.31 Damaged axle guards and suspension spring brackets riveted to the underframe can be straightened or replaced by the workshops.
- 4.32 If the rivets or bolts used to fix the axle guards in place are loose or missing, they shall be replaced by the workshops with self-locking screw bolts or bolts locked by split pins.
- 4.33 The friction surfaces of damping systems acting on the guides of the axle-boxes or swivelling bolster must not be lubricated. Any grease must be removed insofar as possible without demounting. In this case the wagon must be fitted with a Label M.
- 4.34 Welding of wear liners on bogies is only authorised after the axles have been demounted and following instructions from the keeper. Rewelding of cracks on wear liners is not allowed.
- 4.35 Welding and oxygen-cutting are strictly prohibited during the mounting of screw assemblies using high-resistance screws (class 8.8 or above) or bolts (class 8 or above) to attach steps, handles and centre castings.
- Screw assemblies are to be executed in compliance with the rules (e.g., sufficient projection of screw, tightening torque, self-locking screws etc.).
- Welding and oxygen-cutting are prohibited on self-locking screws, irrespective of the type of locking (synthetic or metallic).
- 4.36 During the mounting of screw assemblies with normal-resistance screws (below class 8.8) or bolts (below class 8) to attach steps, handles and centre castings, welding and oxygen-cutting are only permitted if authorised by the keeper. Screw assemblies are to be executed in compliance with the rules (e.g., sufficient projection of screw, tightening torque, self-locking screws etc.).
- Welding and oxygen-cutting are prohibited on self-locking screws, irrespective of the type of locking (synthetic or metallic).

5. Buffing and draw gear

Modules with measures to restore the fitness to run

Reserved

Minimum condition and limit values for dimensions

Buffing gear

- 5.1 The height of the centre of the buffing gear, measured vertically from rail level and at rest, must be:
- for empty wagons maximum 1 065 mm
 - under maximum load minimum 940 mm
- 5.2 Reserved.
- 5.3.1 Buffers at the end of the wagon and buffer fixing bolts must not be missing. All fixing bolts must be tight.
- 5.3.2 * For permanently coupled wagon units, neither buffers nor buffer fixing bolts must be missing at the fixed coupling point. All fixing bolts must be tight.
- 5.4 The locking or fastening devices holding the buffer plungers in place must not be missing or damaged.
- 5.5 The buffer spring and the other parts of the buffer must not have cracks or damage liable to impede the proper working of the buffer. It is acceptable for one buffer at each end of the wagon to be compressible by hand by a maximum of 15 mm.
- 5.6.1 Buffer casings must not be damaged to the extent that their fastenings are no longer sufficiently robust or that buffer plunger guidance is no longer sufficiently guaranteed. The buffer casings and plungers must not be cracked.
- The buffer's visible guide surface must present no more than 2 sharp-edged grooves, each more than 2 mm deep and 60 mm long. This examination shall be performed as a visual inspection, and as a measurement in case of doubt only.
- 5.6.2 For buffers which are to be lubricated, the visible guide surface must be adequately lubricated. Should lubrication be needed, any grease residue must first be removed. Lubrication must then take place by applying a thin layer of grease across the periphery of the guide surfaces.
- 5.7 * There must be no missing or loose rivets or fixing bolts on the buffer heads. This also applies to permanent couplings.
- 5.8 * The contact surfaces of the buffer heads must be sufficiently lubricated. This also applies to permanent couplings.
- 5.9.1 * The contact surfaces of buffer plates must not have more than 2 sharp-edged grooves measuring > 3 mm in depth and > 50 mm in length. This also applies to permanently coupled wagon units.
- 5.9.2 * The buffer plates with wear pads or plastic plates must not
- be broken, cracked right through, missing,
 - have shelling/melding > 3 mm in depth and > 25 mm in length,
 - have loose or missing fastening bolts.

5.10 On wagons fitted with anti-crash devices, these devices must not show signs of having been triggered, nor any trace of deformation.

The anti-crash devices have been triggered if

- the arrow marker is not fully visible,
- the deformation marker is missing or deformed,
- the length of the buffer is visibly shortened,
- the buffer casing is deformed or destroyed.

Draw gear

5.11 No part of the screw coupling gear (coupled or uncoupled) must hang down within 140 mm of the top of the rails.

5.12 The length of the screw coupler must be such that the buffers can at least be brought into contact.

5.13 The screw couplers and draw hooks must not be missing. Any clearance between the chain link and the screw must be less than 10 mm. All of the screw coupler's component parts must be in place.

5.14.1 The screw coupler must be easy to operate and the coupling screw must be sufficiently lubricated and/or greased.

5.14.2 The screw couplers and draw hooks must not be cracked. Nor must they have sustained any damage liable to prevent the vehicle from being coupled to another vehicle or to stop them performing properly.

5.15 Draw bars must not be broken or cracked. Sleeves, bolts or cotter pins must not be broken or missing.

5.16 Draw hook rods and guides must not be worn to such an extent that the draw hook is able to rotate on its axis within the guides.

5.17 If non-continuous draw gear is used, none of the following types of damage may occur:

- fracture or defect on a volute or ring spring,
- deterioration of a rubber or elastomer spring.

5.18 If continuous draw gear is used, none of the springs must not be fractured or damaged. The draw gear guides must not have cracks that are liable to prevent the draw gear from functioning properly.

5.19 The draw hook pin on the screw coupler must be at least 50 mm in diameter.

5.20 When the suspension device on the screw coupler is inoperable or missing, it must be re- paired or replaced.

Indications – Accepted and prohibited practices

5.21 Use of welding to repair draw gear is prohibited. However, electric welding may be used for temporary repairs to broken or cracked draw bars. The wagons concerned must be handled in accordance with Appendix 9 and transported at the rear of the train.

5.22 Wagons fitted with long-stroke shock absorbers whose sliding part is visibly not in the middle position must be dealt with in accordance with Appendix 9.

5.23 When a buffer at one end of the wagon is damaged, both buffers must be replaced. The replacement buffers must be identical. In the case of buffers with a stroke of 105 mm, 130 mm or 150 mm, the replacement buffers must however belong to the same category as the buffers removed. Also, for buffers with a stroke of 130 or 150 mm, the replacement parts must have the same design characteristics as the buffers removed. Buffers with wear inserts in the buffer heads must only be replaced in accordance with the keeper's instructions.

- 5.24 Missing buffer head fastening rivets may be replaced using appropriate screw fasteners. Any sharp edges on the buffer head contact surfaces shall be removed by grinding.
- 5.25 It is forbidden to carry out welding or blowtorch work on or near buffers marked on the casing with a yellow dot (see Appendix 11, point 7.9.4).
- 5.26 Damaged or deformed anti-crash devices shall be dealt with in accordance with the keeper's instructions. Buffers fitted with anti-crash devices must, in principle, be replaced by identical buffers. If anti-crash devices are not available, standard buffers may, exceptionally, be fitted to enable the wagon to continue its journey to be unloaded or sent to the workshop for repairs. In this case, a K Label as shown in Appendix 9, annex 11 shall be affixed, together with the sign shown in Appendix 11, points 5.4 or 5.5.
- 5.27 Permanently coupled wagons must be coupled and uncoupled in line with the keeper's instructions.
- 5.28 Welding and oxygen-cutting are strictly prohibited during the mounting of screw assemblies using high-resistance screws (class 8.8 or above) or bolts (class 8 or above) to attach buffers and draw gear. Screw assemblies are to be executed in compliance with the rules (e.g., sufficient projection of screw, tightening torque, self-locking screws etc.).
- Welding and oxygen-cutting are prohibited on self-locking screws, irrespective of the type of locking (synthetic or metallic).
- 5.29 During the mounting of screw assemblies with normal-resistance screws (below class 8.8) or bolts (below class 8) to attach buffers and draw gear, welding and oxygen-cutting are only permitted if authorised by the keeper. Screw assemblies are to be executed in compliance with the rules (e.g., sufficient projection of screw, tightening torque, self-locking screws etc.). Welding and oxygen-cutting are prohibited on self-locking screws, irrespective of the type of locking (synthetic or metallic).

6. Vehicle body and accessories

Modules with measures to restore the fitness to run

Reserved

Minimum condition and limit values for dimensions

Provisions applicable to all wagons:

- 6.1.1 The wagon body, superstructures and all additional devices must not be damaged in a way that could lead to deterioration or loss of the load or constitute a safety hazard for railway operations and/or a risk for persons or the environment.
- 6.1.2 The hydraulic systems must not leak. Without further instructions from the keeper, sealing must only be carried out by tightening the hydraulic connections.
- 6.2 The wagon body and its parts must not foul the loading gauge.
- 6.3 No part of the heating coupling and other coupling devices (coupled or uncoupled) must hang down within 140 mm of the top of the rails.
- 6.4 Moving parts of the wagon and the devices used to control them must not have visible damage that prevents them from functioning normally.
- 6.5 None of the wall or floor boards must be missing, broken, split or damaged to the point where the load might be lost or damaged as a result of damp.
- 6.6 The sliding doors must be mounted in such a way that they cannot come off their runners. Drop sides must be secured so they cannot part from their hinges or fastenings.
- 6.7 It must be possible to close and lock all doors and sliding walls completely and securely. They must not be missing or have come out of their runners.
- 6.8 The doors must have no deformation or holes that could lead to loss of the load.
- 6.9 No guiding or locking systems (door frames, hinges, bolts, latch hooks or handles) must be missing or be dislodged, broken or deformed.
- 6.10 Two handrails for use by shunting staff (during coupling) must be fitted below each head- stock. All steps, handrails, ladders and walkways must be safe to use and free from cracks. This provision also applies to their fastenings and supporting structures.
- 6.11 Steps may be twisted, deformed or tilted to a maximum of 20 mm.
- 6.12 The clearance between handrails and the nearest part of the wagon must be at least 60 mm.
- 6.13 Plates carrying markings, folding panels and label-holders must not be missing and must be properly secured.
- 6.14 The following markings as specified in Appendix 11 must be fully present and legible:
- wagon number and signs as depicted in Appendix 11 points 2.1 and 2.2,
 - tare,
 - braked weight of the hand brake,
 - load limits,
 - capacity of tank wagons,
 - goods for which tank wagons are used,
 - length over buffers of wagon,
 - the high voltage warning sign "Caution – Electrical hazard" on wagons fitted with steps or ladders placed at a height of more than 2 m,
 - maintenance (overhaul) plate,
 - signs indicating the presence of anti-crash devices,
 - diagonal stripes for wagons with long-stroke shock absorbers.

Additional provisions for covered wagons:

- 6.15 Ventilation flaps must not be missing or damaged.
- 6.16 Control gear, shutters and retaining brackets must not be unhooked, dislodged or de- formed.
- 6.17 The roof cover and weatherboard must not be loose or deformed.
- 6.18 It must be possible to close and lock opening roofs to prevent them from coming open unexpectedly. None of the controls must be missing, deformed or inoperable. The roofs must lie in their runners.
- 6.19 It must be possible to use roof hatches correctly.

Additional provisions for open wagons:

- 6.20 It must be possible to close and lock the side walls to prevent them from opening unexpectedly.
- 6.21 It must be possible to close and lock the end flaps to prevent them from opening unexpectedly.
- 6.22 The locking systems for the end flaps (pins, camshafts, rings, shafts) must not be missing, broken or cracked. They must be fit for use.
- 6.23 The cantrails must not be deformed, broken or cracked so as to foul the gauge.

Additional provisions for flat wagons:

- 6.24 It must be possible to lift and secure the drop sides.
- 6.25 The hinges, pins and securing devices of the drop sides must not be missing or broken. They must be fit for use.
- 6.26 Detachable, swivelling and retractable stanchions must not be missing, broken or cracked.
They must not be deformed, broken or torn to the extent of fouling the loading gauge. This provision also applies to the stanchion mountings and securing devices.
The stanchion fastenings must be effective.
- 6.27 Folding bolsters must not be loose.

Additional provisions for tank wagons^{1),2),3)}:

- 6.28 * Tanks must not have sharp-edged deformations (even if there is no loss of the goods carried).
- 6.29 * Cracks in tank cradles are not accepted. If the tank is fastened to the underframe using bolts or rivets, none of these must be missing.
- 6.30 * The welded joints on the tank and the underframe must not be cracked.
- 6.31 * Ladders, platforms and guard rails must be safe to use and must not be loose.
- 6.32 * Tank cladding, sunroofs and insulation must not have come loose.

¹⁾ The points indicated by a * are mandatory only for RID tank wagons (visual inspections).

²⁾ Tank wagons are wagons used for transporting liquids, gases, powdered or granular goods (visual inspections)

³⁾ The corrective maintenance operations covered under points 6.28 - 6.30 and 6.33 - 6.38 may only be performed on RID tank wagons with the keeper's consent (e.g., Model H)

- 6.33 The tanks and their filling and emptying devices must not leak. It must be possible to seal them hermetically, with the exception of the automatic ventilation devices (Appendix 11, point 6.3).
- 6.34 * Screw caps must not be missing.
- 6.35 * The blind flanges must not be missing or loose. All the fastening screws must be in place.
- 6.36 The emergency control screw for the emptying valve must be unscrewed.
- 6.37* The indicator on the emptying valve must be in good condition and legible.
- 6.38 The dome hatch must be present. It must be possible to close it hermetically.

Additional provisions for mechanically sheeted wagons:

- 6.39.1 It must be possible to close and lock the mechanical sheeting correctly (indicator visible). This requirement also applies to the end hoops' top locking system.
- 6.39.2 Provided that no repair instructions have been provided by the keeper, repairs are carried out using a repair kit on the basis of cold bonding in accordance with the instructions provided by the repair kit manufacturer.
- 6.39.3 Elements to hold and fasten sheeting shall be kept in a good condition for operation. Relaxed (loose) ropes shall be re-tensioned and severed ropes shall be repaired or replaced.

Additional provisions for wagons with telescopic hood:

- 6.40 It must be possible to close and lock the hoods correctly, keeping them in the guide rails provided.

Additional provisions for flat bogie wagons for carrying road and rail vehicles:

- 6.41 The moving headstocks at each end must not be damaged. It must be possible to lock them from both sides.
- 6.42 The seating device, seating device bolts, securing chains and chain eyes must be fit for use.

Additional provisions for ACTS carrier wagons:

- 6.43 The swivel frames must not be damaged to the extent that they cannot be properly fastened and locked.
- 6.44 The snap locks must function properly.
- 6.45 The central lock must function and clearly show the "locked" position.
- 6.46 It must be possible to erect the stanchions correctly.

Additional provisions for car-carrying wagons:

- 6.47 It must be possible to raise and secure the end boards and crossing gangways.
- 6.48 The upper loading deck must rest on the supporting brackets and be properly secured. The indicator device must function.
- 6.49 None of the accessories must be loose (scotches, wheel scotch guide-pieces, crank handles, lifting or lowering device, end boards, crossing gangways).

Additional provisions for self-discharging wagons:

- 6.50 It must be possible to close and lock all valves and hatches.
- 6.51 No part of the locking and discharging system must be loose.

Indications – Accepted and prohibited practices

6.52 When deformation has occurred and the vehicle gauge profile must be verified, the provisions of point 4, volume 1 of the Loading Guidelines shall be applied.

Exception: for wagons built in accordance with UIC Leaflet 505/IRS 50505 and whose width exceeds that obtained by application of point 4, volume 1 of the Loading Guidelines (these wagons are not specially marked), the wagon keeper should be contacted to find out the permitted width of the wagon.

Failing a reply from the keeper, point 4 of volume 1 of the Loading Guidelines shall be applied for safety reasons.

6.53 Parts made from plastic or plywood (e.g., roof covers and side wall panels) must not be repaired with nails. These wagons carry the sign specified in Appendix 11, point 2.14.

6.54 Rivets used for fastening the tanks of tank wagons may be replaced by bolts when missing.

6.55 Welding work on tanks may only be carried out by approved workshops with the keeper's agreement.

B. HANDLING OF WAGONS AFTER SPECIFIC INCIDENTS

0. Principle

After specific incidents, the user RU must ensure that any damage or presumed damage that the wagon has suffered will not give rise to consequential damage. To this end, this chapter sets out a number of provisions to be complied with when returning the wagon to running order. The decision on whether the wagon is fit for use rests with the keeper.

The user RU shall perform additional tests to ensure that no wagon damage, which may affect the wagon's fitness for use, has not occurred. In the case of tank wagons, wagons with specific superstructures, which are not described in point 6 of chapter A, and if the workshop is not certain that the points defined are sufficient, the RU contacts the keeper to request specific instructions to restore the wagon's ability to run. If workshops are unable to restore the wagon to the minimum condition specified, the wagon shall be referred to the keeper for a decision on what action to take (in accordance with Appendix 9).

The specific incident and the wagon associated with the number(s) of the wheelset(s) concerned must be indicated to the keeper.

1. Derailment

The inspection must be adapted according to the information available.

If a wagon derails, the following checks must be performed at a minimum:

- wheelsets, in accordance with Chapter A, 1.1.2, 1.1.3, 1.6.1, 1.6.2, 1.8, 1.10 to 1.17, 1.20 and 1.21 as well as notches in the wheel flange which are due to the derailment,
- springs, in accordance with Chapter A, points 2.1 to 2.8,
- underframe, running gear and bogies in accordance with Chapter A, points 4.1 to 4.6, 4.8 to 4.12, 4.14 to 4.18, 4.20, 4.21, 4.24, 4.25, 4.26,
- traction and buffing gear: Chapter A, points 5.1 to 5.6.1, 5.7, 5.9, 5.10, 5.13, 5.14.2, 5.15, 5.17, 5.18, 5.20,
- Vehicle body and accessories according to point 6 of chapter A, if applicable,
- for tank wagons, inspection of the tank in accordance with the keeper's instructions,
- inspection of damages at grounding cables.

In the case of wagons derailed at a speed of >10 km/h, or if the speed cannot be established, the wheelsets concerned must be removed without prior inspection.

Before being sent, the wheelsets that have derailed must be clearly marked so that the keeper or the keeper's workshop can recognise that the wheelset has derailed (**Model H^R**).

2. Exceptional impacts

When a wagon has suffered an exceptional impact, it is assumed that the speed of impact was greater than 12 km/h.

In this case, the following tests shall be carried out:

- wheelsets in accordance with Chapter A, 1.1.2, 1.1.3, 1.6.1, 1.6.2, 1.8, 1.10 to 1.17, 1.20 and 1.21,
- springs in accordance with Chapter A, points 2.1 to 2.8,
- underframe, running gear and bogies in accordance with Chapter A, points 4.1 to 4.6, 4.8 to 4.12, 4.14 to 4.18, 4.20, 4.21, 4.24, 4.25, 4.26,
- traction and buffing gear: Chapter A, points 5.1 to 5.6.1, 5.7, 5.9, 5.10, 5.13, 5.14.2, 5.15, 5.17, 5.18, 5.20,
- Vehicle body and accessories according to point 6 of chapter A, if applicable,
- tank wagons: inspection of the tank in accordance with the keeper's instructions.

If the speed of impact is found to have exceeded 25 km/h, the wheelsets must be removed.

Before being sent back, the dismantled wheelsets must be marked so that the keeper or the workshop can identify them as having been subject to an exceptional impact (**Model H^R**).

3. Overloading and exceeded concentrated loads

When a wagon is brought in because it has been overloaded (whole wagon, bogie or wheelset) or the concentrated loads are exceeded, the following inspections and measurements should be carried out according to the overload percentage in relation to the maximum load for the wheelset concerned:

	Overload %	Maintenance operations
1	0% to 2% (inclusive)	– No operation
2	> 2% to 10% (inclusive)	<ul style="list-style-type: none"> – inspection of axle and wheels in accordance with Chapter A, 1.1.2, 1.1.3, 1.6, 1.8, 1.10 to 1.18, 1.20 and 1.21. – visual inspection of suspension springs for ruptures, cracks and deformation – visual check for traces of contact on the springs and parts of the underframe or bogie – inspection of the underframe, running gear and bogies in accordance with Chapter A, points 4.1 to 4.6, 4.8 to 4.12, 4.14 to 4.18, 4.20, 4.21, 4.24, 4.25 – transmission of information on overloading and inspection results to the keeper
3	> 10%	<ul style="list-style-type: none"> – removal of the wheelset and transmission of information on overloading to the keeper by means of Model H^R – visual inspection of suspension springs for ruptures, cracks and deformation – visual check for traces of contact on the springs and parts of the underframe or bogie – inspection of the underframe, running gear and bogies in accordance with Chapter A, points 4.1 to 4.6, 4.8 to 4.12, 4.14 to 4.18, 4.20, 4.21, 4.24, 4.25 – transmission of inspection results to the keeper
		<ul style="list-style-type: none"> – visual inspection of suspension springs for ruptures, cracks and deformation – visual check for traces of contact on the springs and parts of the underframe or bogie – inspection of the underframe, running gear and bogies in accordance with Chapter A, points 4.1 to 4.6, 4.8 to 4.12, 4.14 to 4.18, 4.20, 4.21, 4.24, 4.25 – transmission of inspection results to the keeper

All of the information provided to the keeper must relate to the maximum permissible load per wheelset or the maximum permissible concentrated loads. If this value is not indicated on the wheelset, the maximum permissible line classification marked on the wagon must be taken into account.

If the overloaded wheelsets are marked with a white cross on the axle, the maintenance operations described in the table above shall be limited to the marked axles only.

In case of doubt, the wheelset(s) should be replaced without prior inspection and marked as having been subject to overloading (**Model H^R**) before being sent back to the wagon keeper.

4. Flooding

The following inspections and measures shall be performed on wagons that have stood with all or part of their underframe under water in order to return them to running order, where appropriate after cleaning:

- replacement of all wheelsets,
- before they are sent back, all the wheelsets that have been subject to flooding must be clearly marked so they are recognisable to the wagon keeper or his workshop as having suffered potential damage from water (Model H^R),
- visual inspection of suspension springs to check for corrosion that could lead to a rupture of the spring,
- replacement of any buffers that were below the waterline,
- draining of water from the main brake pipe. The wagon should be handled with the brake isolated in accordance with Appendix 9.

5. Contact with energized catenary

When parts of the wagon body have come into contact with energised catenary wires, the axle-boxes are likely to have sustained damage from the passage of electric current.

In cases such as these, the following measures shall be taken:

- replacement of all wheelsets on the wagon,
- before they are sent back, all the wheelsets that have been affected by the electric current must be clearly marked so they are recognisable to the wagon keeper or his workshop as having suffered potential damage from electric current (Model H^R),
- inspection of the vehicle body to check for other damage with potential consequences for the wagon's fitness to run,
- also check for burn marks or evidence of fusion, particularly on grounding cables, springs, suspension and other spring connectors,
- for tank wagons, inspect the tank in accordance with the keeper's instructions.

Appendix 10, Annex 1

SIGNS INDICATING OUT-OF-ROUNDNESS OF WHEELS

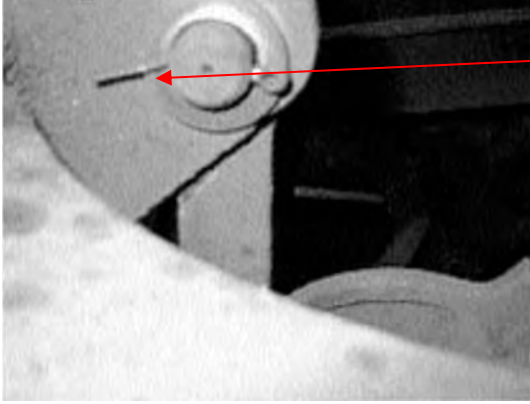
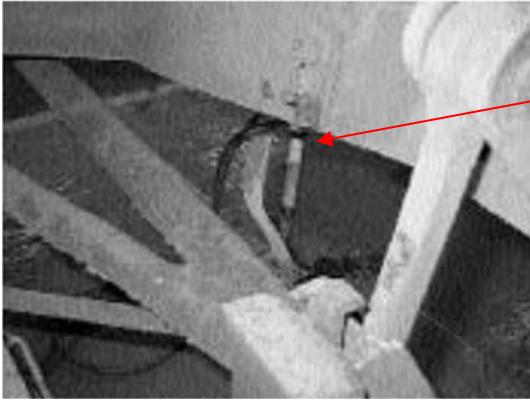
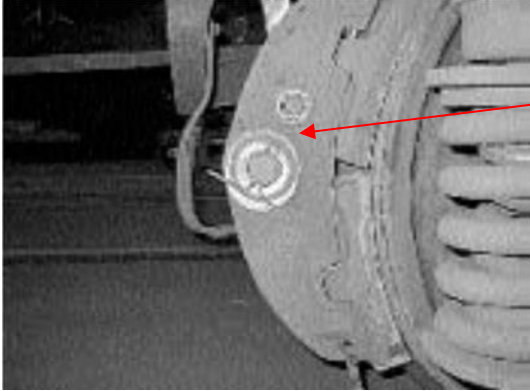
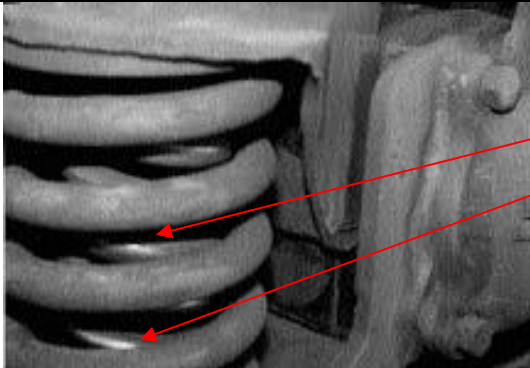
	<p>Picture 1: Sheared-off pin</p>
	<p>Picture 2: Broken safety stirrup</p>
	<p>Picture 3: Shiny traces on the brake triangle end washer</p>
	<p>Picture 4: Shiny traces on the load spring</p>

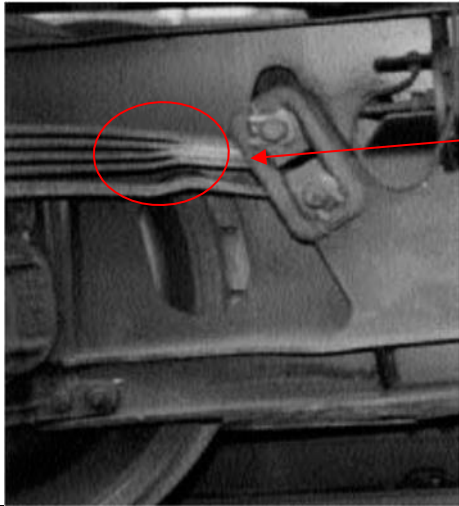

Picture 5:
Areas shiny with wear, visible from the outside, on the friction points of the spring leaves of parabolic spring suspensions

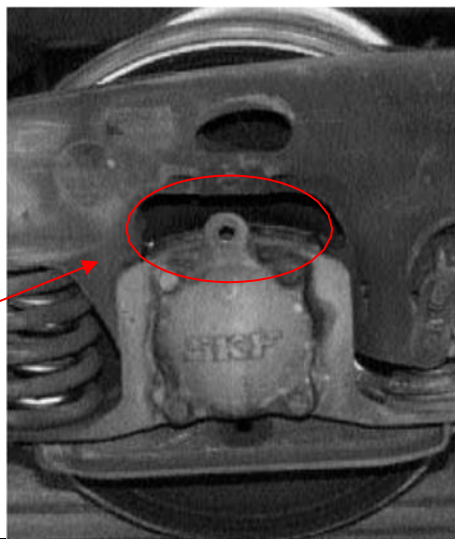

Picture 6:
Lifting safety catch missing or loose

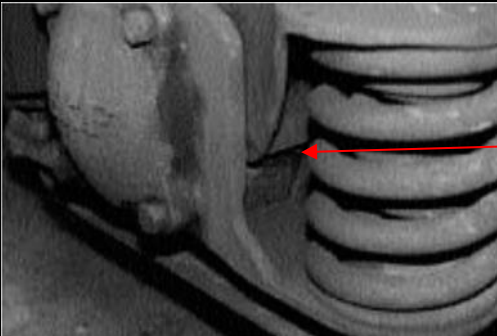

Picture 7:
Manganese wear plates on bogies and axle-boxes detached



Picture 8:
Irregular contact surface on the edge of tyred wheel rim



Picture 9:
Major irregular crushing of the edge of the tyred wheel rim

Appendix 10, Annex 2

DIAGRAM OF THE Y25 BOGIE SUSPENSION

Picture 1 – Bogie with springs for axle-load of 20 tonnes

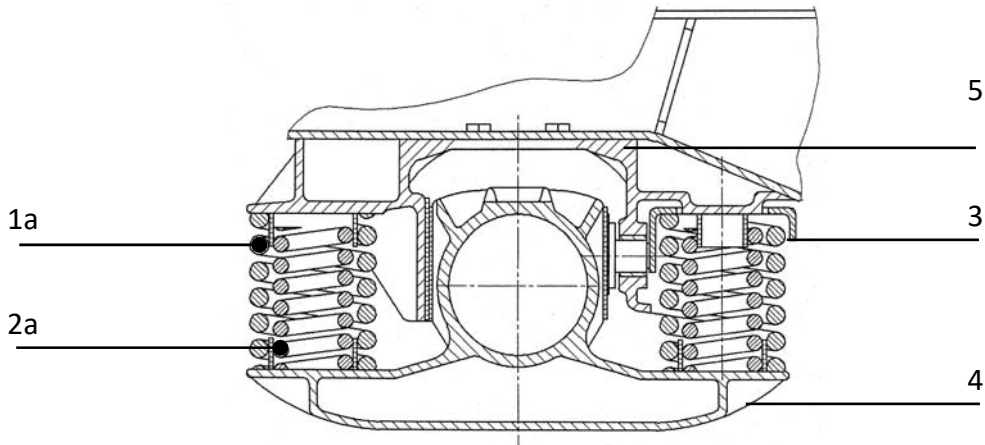

- 1a tare spring for 20 t axle-load, right-wound
- 2a load spring for 20 t axle-load, left-wound
- 3 spring cap
- 4 axle-box
- 5 axle-box guide piece

Picture 2 – Bogie with springs for axle-load of 22.5 tonnes

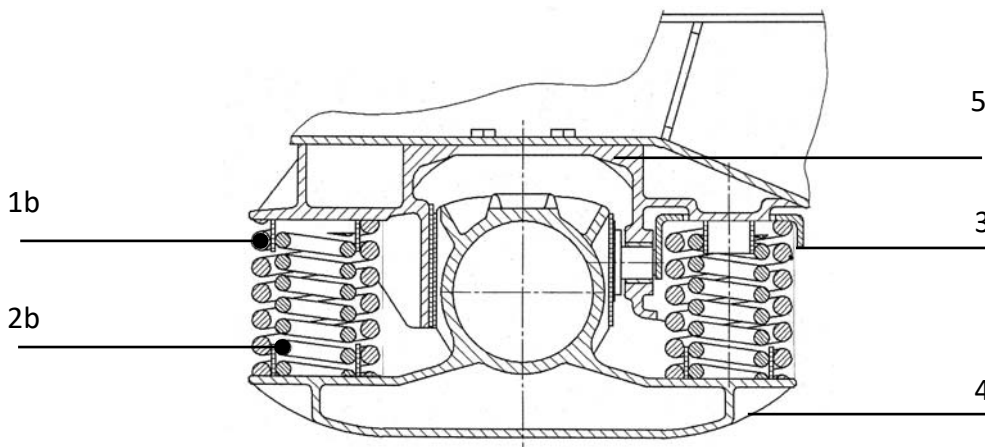

- 1b tare spring for 22.5 t axle-load, left-wound
- 2b load spring for 22.5 t axle-load, right-wound
- 3 spring cap
- 4 axle-box
- 5 axle-box guide piece

Appendix 10, Annex 3

EUROPEAN VISUAL INSPECTION CATALOGUE (EVIC) FOR WHEELSETS

Preamble

1. The documents contained in this annex describe procedures for the visual inspection of wagon axles.

Chapter A:

European visual inspection catalogue (EVIC) for wagon axles.

Chapter B:

Implementation guide for the European visual inspection catalogue (EVIC) for wagon axles.

2. Axles requiring removal following EVIC must be marked in a clearly visible and indelible manner with "EVIC", the defect code and the number of the corresponding wheelset. This data must also be noted on Form H^R (Appendix 7 of the GCU) when placing an order for replacement wheelsets from the wagon keeper.
3. If a wagon is sent to the workshop because of axle damage according to Appendix 9 of the GCU, the axles of the wheelsets concerned shall not be subjected to visual inspection. Only the provisions of Appendix 10 of the GCU on corrective and preventive maintenance shall be applicable to these wheelsets.

A. European visual inspection catalogue (EVIC)

The following pages represent the complete defect catalogue.

**EUROPEAN VISUAL
INSPECTION CATALOGUE
(EVIC)
FOR WAGON AXLES**

DAMAGE CATEGORY



Painted axles		
30	No defects or admissible defects (pitting)	OK
31	Mechanical damage – sharp edged circumferential fluting	X (not ok)
32	Mechanical damage – smooth edged circumferential groove	X (not ok)
33	Mechanical damage – sharp edged notching	X (not ok)
34	Mechanical damage – cracks	X (not ok)
35	Surface damage – large and heavily corroded areas	X (not ok)
36	Surface damage – single, deeply pitted corrosion scars	X (not ok)
37	Coating damage – with or without corrosion	C
Unpainted axles		
40	No defects – admissible surface appearance	OK
41	Mechanical damage – sharp edged circumferential fluting	X (not ok)
42	Mechanical damage – smooth edged circumferential groove	X (not ok)
43	Mechanical damage – sharp edged notching	X (not ok)
44	Mechanical damage – cracks	X (not ok)
45	Surface damage – very heavy, deep and large corrosion	X (not ok)
46	Surface damage – single, deeply pitted corrosion scars	X (not ok)
All axles		
50	Abutment area	X (not ok)

CRITERIA FOR PAINTED AXLES

30 No or admissible defects found on the axle surface - smooth pitting		Painted axles
Salient information:		
	Pitting may occur either round the entire perimeter or intermittently and is characterised by smoothly rounded contours with no sharp transitions. This type of pitting may arise in the course of maintenance work. The anti-corrosion coating is undamaged.	
Decision:		
	Pitted axles whose coating is nevertheless undamaged may remain on the vehicle.	
		OK

Pictorial representation:			
			

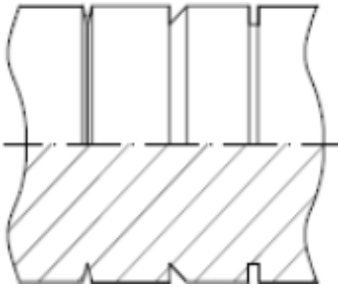
31 Mechanical damage – sharp edged circumferential fluting		Painted axles
Salient information:		
	Flutes are characterised by sharp edged circumferential sharp-edged transitions.	
	Mechanical damage to the base material in the form of fluting is inadmissible.	
Decision:		
	Check on the wagon why this damage could have occurred and repair accordingly.	
	Remove from service according	Case A
		X

Pictorial representation:		
		



32 Mechanical damage – smooth edged circumferential grooves		Painted axles
Salient information:		
	Characterised by smooth transitions in the edges (GCU Appendix 9, 1.6.2). Pitting that arises during operation (caused e.g., by brake lever connectors dragging) involves damaged anti-corrosion coating	
Decision:		
	Check on the wagon why this damage could have occurred and repair accordingly.	
	Remove from service	Case B
	if there is damage to the base material > 1mm: (acc. GCU)	Case A
		X

Pictorial representation:







33 Mechanical damage – sharp edged notching		Painted axles
Salient information:		
	Sharp edged notches occur locally and are characterised by sharp-edged transitions.	
	Mechanical damage to the base material in the form of notching is inadmissible.	
Decision:		
	Remove from service (according to GCU criteria)	
		Case A
		X

Pictorial representation:			
			

34 Mechanical damage – cracks		Painted axles
Salient information:		
	Cracks occur locally on the shaft material (not on the painting) and are characterised and visible by fine lines.	
	Mechanical damage to the base material in the form of cracks is inadmissible.	
Decision:		
	Remove from service	Case A
		X

Pictorial representation:			
			

35 Surface damage – large and heavily corroded areas		Painted axles
Salient information:		
	Surface damage to base material in form of large and heavily corroded areas (old corrosion protection) is inadmissible.	
Decision:		
	Remove from service.	
		Case B
		X









Pictorial representation:			
			

36 Surface damage – single, deeply pitted corrosion scars		Painted axles
Salient information:		
	Surface damage to the base material in the form of marked, local corrosion scars (resulting e.g. from chemical effects) is inadmissible.	
Decision:		
	Remove from service.	Case B
		X

Pictorial representation:			
			





37 Coating damage – with or without corrosion		Painted axles
Salient information:		
	Minor lack of an anti-corrosion coating, whether corrosion is involved or not.	
Decision:		
	Leave in service acc. case C and/or repair the damage in situ on the wheelset.	
		Case C
		C

Pictorial representation:



			
			

CRITERIA FOR UNPAINTED AXLES

40 No defect - admissible surface appearance		Unpainted axles
Salient information:		
	There exist maintenance rules that do not require any anti-corrosion protection. Axles and wheels stay unpainted in such cases and show a thin and uniform layer of rust on their surfaces in service.	
Decision:		
	Deep corrosion is not accepted.	
	Leave in service wheelset "as new", "very good", "good" and "acceptable".	
		OK

Pictorial representation:			
As new	Very Good	Good	Acceptable
			

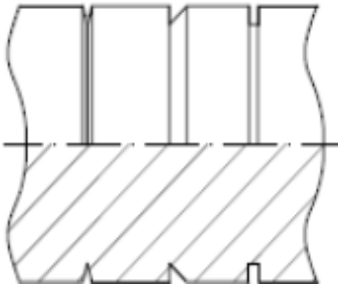
41 Mechanical damage – sharp edged circumferential fluting		Unpainted axles
Salient information:		
	Flutes are characterised by sharp edged circumferential sharp-edged transitions.	
	Mechanical damage to the base material in the form of fluting is inadmissible.	
Decision:		
	Check on the wagon why this damage could have occurred and repair accordingly.	
	Remove from service according	Case A
		X



Pictorial representation:		
		

42 Mechanical damage – smooth edged circumferential grooves		Unpainted axles
Salient information:		
	Characterised by smooth transitions in the edges (GCU Appendix 9, 1.6.2). Pitting that arises during operation (caused e.g., by brake lever connectors dragging) involves damaged anti-corrosion coating	
Decision:		
	Check on the wagon why this damage could have occurred and repair accordingly.	
	Remove from service.	Case B
	if there is damage to the base material > 1mm: (acc. GCU)	Case A
		X

Pictorial representation:

The pictorial representation consists of four photographs showing mechanical damage on an axle. The first photo shows a close-up of a smooth transition on the axle surface. The second photo shows a close-up of a pitted area on the axle. The third photo shows a close-up of a pitted area on the axle. The fourth photo shows a close-up of a pitted area on the axle.

43 Mechanical damage – sharp edged notching		Unpainted axles
Salient information:		
	Sharp edged notches occur locally and are characterised by sharp-edged transitions	
	Mechanical damage to the base material in the form of notching is inadmissible.	
Decision:		
	Remove from service (according to GCU criteria).	
		Case A
		X

Pictorial representation:			
			

44 Mechanical damage – cracks		Unpainted axles
Salient information:		
	Cracks occur locally and are characterised and visible by fine lines.	
	Mechanical damage to the base material in the form of cracks is inadmissible.	
Decision:		
	Remove from service.	
		Case A
		X

Pictorial representation:			
			

45 Surface damage – large and heavily corroded areas		Unpainted axles
Salient information:		
	Surface damage to base material in form of large and heavily corroded areas (old corrosion protection) is inadmissible.	
Decision:		
	Remove from service.	
		Case B
		X

Pictorial representation:			
			

46 Surface damage – single, deeply pitted corrosion scars		Unpainted axles
Salient information:		
	Surface damage to the base material in the form of marked, local corrosion scars (resulting e.g., from chemical effects) is inadmissible.	
Decision:		
	Remove from service.	Case B
		X

Pictorial representation:			
			

ABUTMENT AREA

50 Abutment area		All axles
Situation:		
	Normally, the abutment area cannot be inspected sufficiently for wheelsets mounted in the wagon.	
Recommendation:		
Only if there is a clear indication on mechanical or corrosion damages		
	Take wheelset out.	Case A
		X
If not judgeable		
	Leave wheelset in service	
		OK

Pictorial representation:			
Not acceptable	Not judgeable		
			

B. Implementation Guide

The following pages represent the complete implementation guide.

**Implementation Guide for the
EUROPEAN VISUAL
INSPECTION CATALOGUE (EVIC)
FOR FREIGHT WAGON AXLES**

Table of contents

1. Definitions
2. Basics and preparing inspections
3. Conducting the visual inspections

1. Definitions

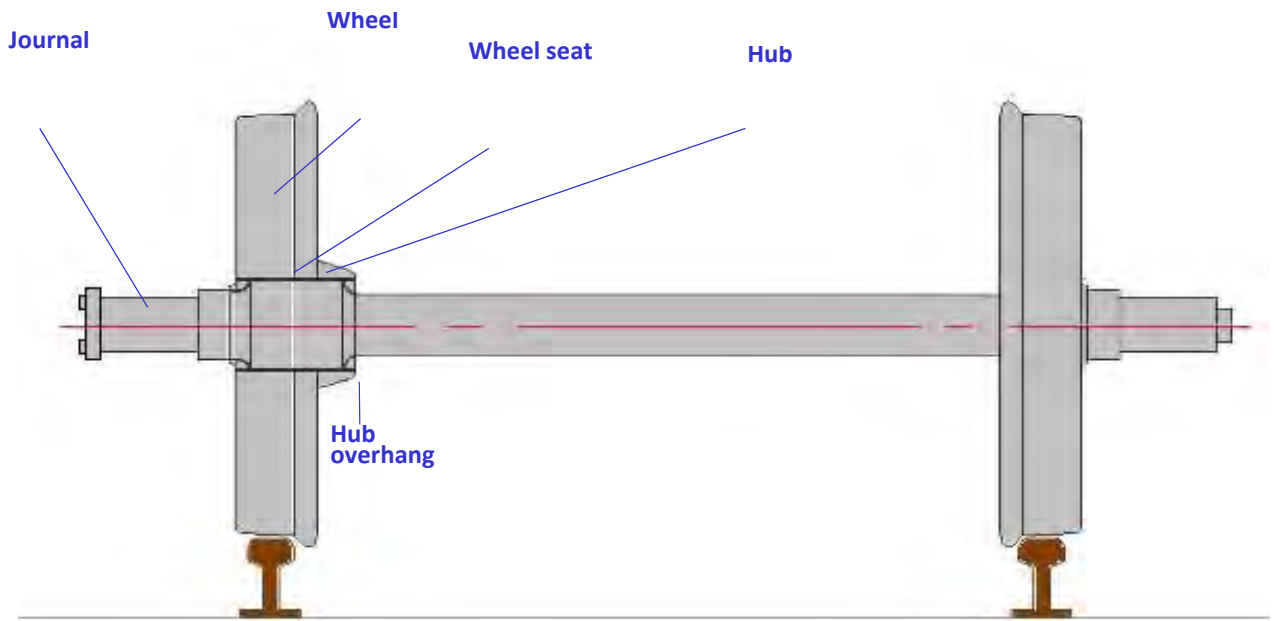

Wheelset

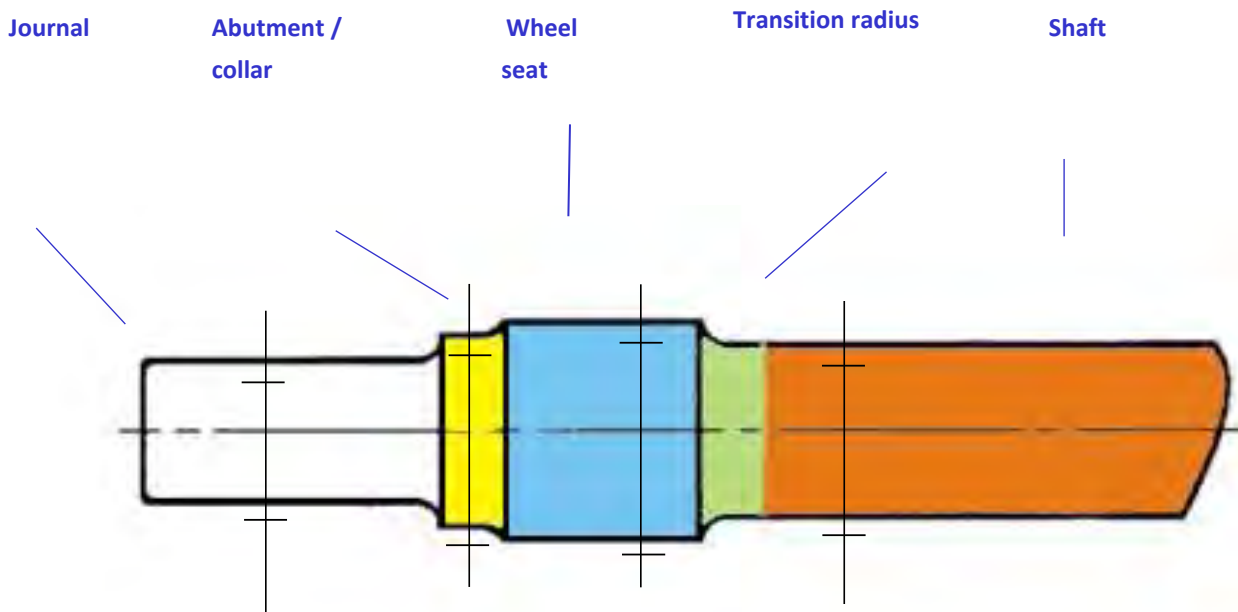

Axle

In the EVIC procedure instructions, the meaning of several expressions is as follows:

Replace = take the wheelset out of the wagon (and repair it in a suitably competent workshop, if possible).

Repair = repair the damage in situ (wheelset mounted) according to the relevant rules

Remove from service = replace or repair (in situ if possible) according to the criteria

2. Basics

2.1 Mandating and invoicing the EVIC inspection

The RU or its auxiliary must send the keeper the EVIC code for the operation performed on the wagon (as per Appendix 10, Annex 6) within one month of the wagon exiting the workshop.

In case of a replacement of “EVIC failed” wheelset, workshop and keeper need to communicate according to appendix 7 (Model H^R).

2.2 Staff qualifications

The inspections have to be conducted by staff qualified in application of this Visual Inspection Catalogue.

It is not necessary for the operatives conducting such visual inspections to be qualified as NDT visual inspectors on the basis of a standard.

The staff involved in this inspection should be trained one day for the correct use of this procedure.

It is under the responsibility of the workshop to update a list of trained workers for the use of the present procedure.

3 Conducting the visual inspection

3.1 Execution of the visual inspection

The Visual Inspection of the freight wagon’s axle shafts for damage to material and coating (if existing) is mandatory

- during light maintenance
- each time the wagon is in a workshop (not mobile team)

and if one of the following conditions is fulfilled:

- the wagon is on a pit or
- the wagon is lifted

In case of non-judgeable defects (not sufficiently detailed by the descriptions in the EVIC), the executor of the EVIC inspection must contact the keeper for further instructions.

A replacing wheelset for a sorted-out axle must be in an “EVIC ok” status.

The EVIC doesn't replace existing maintenance rules. First, existing maintenance rules must be applied, then the EVIC check. If an axle is sorted out with current maintenance rules, it is not necessary to apply the EVIC.

The visual inspection covers the complete area of the axle-shaft surface between the wheels. See special instructions for the abutment area in the EVIC.

The inspection area is to be examined for

- mechanical damage (fluting, pitting and notching, cracks),
- surface damage (areas eaten away, corrosion scars),
- coating damage (with and without corrosion) if coating system existing.

Reference images in EVIC (typical damage features) are used for identifying inadmissible forms of damage.

It is not foreseen to clean the axle. In case of doubt, clean axle (locally) to allow examination.

If natural light intensity is too poor, a supplementary white light source must be used in order to obtain an adequate visibility on the axle.

Axle shafts with inadmissible forms of damage are to be repaired according to the prescriptions, if possible. Otherwise, the axles must be replaced.

An example for an adequate position for the staff conducting the visual inspection is given in the figure below.

If the wheelset cannot rotate (if the wagon is not lifted up), the visibility of the full surface of the axle must be assured in a different way.

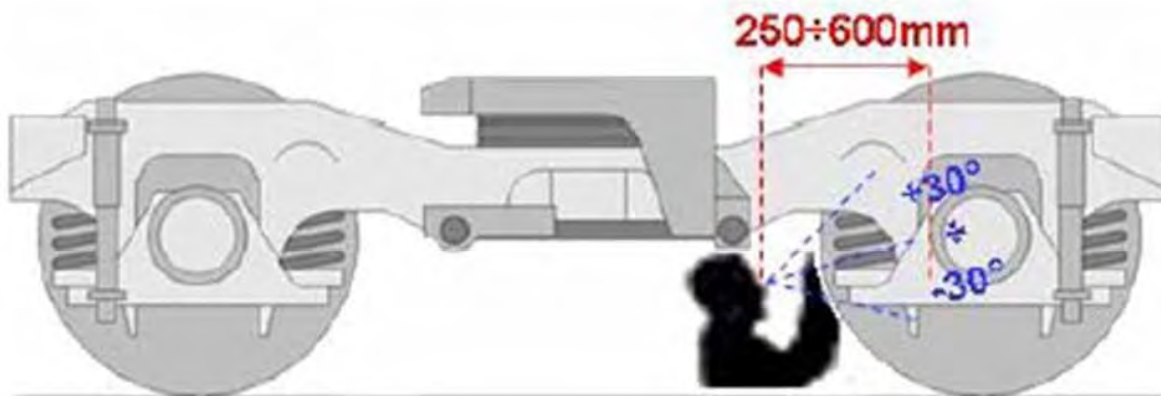

Figure 2 – Inspection angle and distance

3.2 Actions to be taken after inspection (cases)



The following cases describe the actions to be taken after a visual inspection of the axle:



- A Remove the wheelset from service without delay,
- B Remove the wheelset from service after unloading the wagon and/or sending back to home workshop,
- C Leave wheelset in service until the next revision/overhaul of the wagon or repair the damage in situ on the wheelset.
In the next revision/overhaul, the remove from service is mandatory.

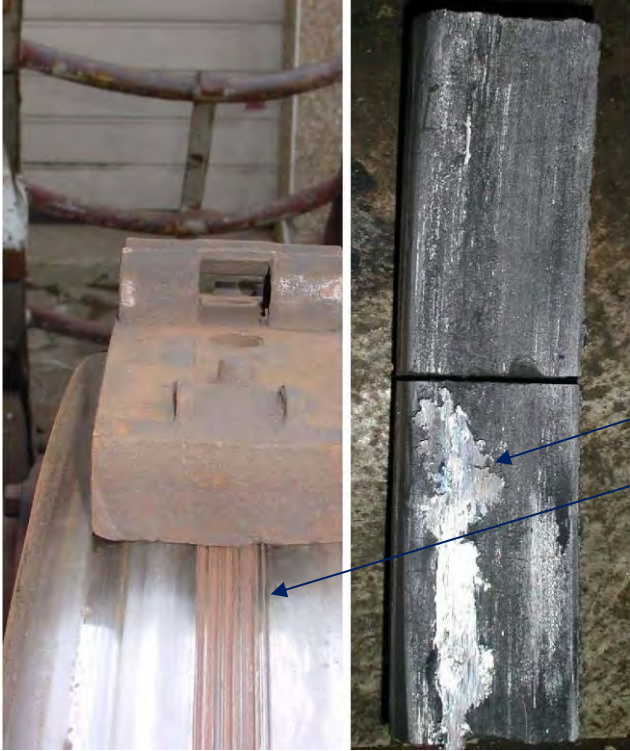

Remove from service = replace or repair (in situ if possible) according to the criteria.

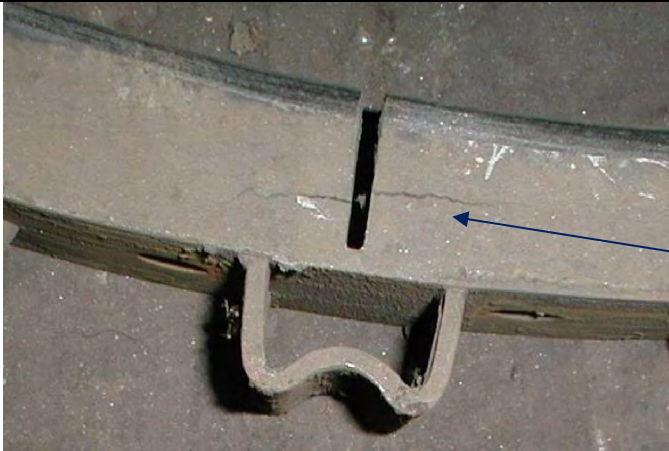

Appendix 10, Annex 4

COMPOSITE BRAKE BLOCKS: WHEN TO REPLACE AND NOT TO REPLACE

Picture	Description, limit value	Action to be taken
	<p>Picture 1: Most of tread displays hollowing (e.g. grooves) and/or shiny metallic marks</p>	<p>Replace</p> <p><u>Note:</u> Check wheel tread in accordance with Chapter A 1.6.1</p>
	<p>Picture 2: Friction material has become detached from plate over a length of > 25 mm</p>	<p>Replace</p>

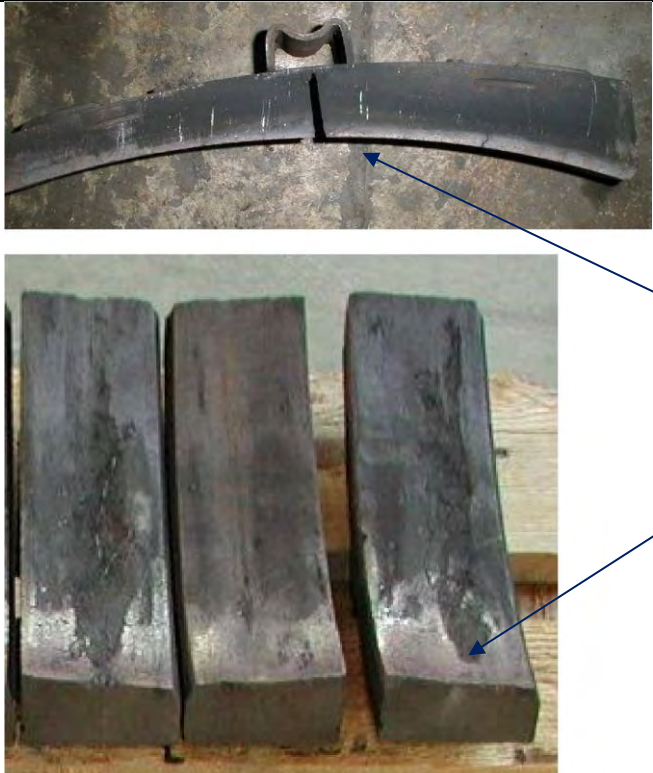
Picture	Description, limit value	Action to be taken
	<p>Picture 3: Crack on the expansion joint (designated breaking-point)</p> <p>Incipient cracking or crack on brake block</p>	<p>Do not replace</p>
	<p>Picture 4: Incipient cracking of > 25 mm parallel to the wheel circumference</p>	<p>Replace</p>
	<p>Picture 5: Smallest thickness is below 10 mm</p>	<p>Replace</p>

Picture	Description, limit value	Action to be taken
	<p>Picture 6: Incipient radial cracking in friction material</p>	<p>Do not replace</p>
	<p>Picture 7: Radial crack in the brake block from the friction surface to the plate: the brake block displays a radial crack from the friction surface to the plate/edge of the plate, not located on the expansion joint (designated breaking-point).</p>	<p>Replace</p>
	<p>Picture 8: "White film" on surface of contact area and to a depth of 10 mm or significant shelling on the contact surface and heavy carbonisation</p>	<p>Do not replace</p> <p><u>Note:</u> Check wheelset in accordance with Chapter A 1.18</p>

Picture	Description, limit value	Action to be taken
	<p>Picture 9: Branched thermal crack pattern, mainly axial (not thermal cracks, cf. vitrification) and carbonisation</p>	<p>Do not replace</p>
	<p>Picture 10: Shelling of the friction material along more than ¼ of the length of the block (corresponds to a total length of > 63mm for a 250 mm brake block or a total length of > 80 mm for a 320 mm brake block)</p>	<p>Replace</p>
	<p>Picture 11: Damage to brake block due to metal build-up on the wheelset or wheel flat</p>	<p>Replace</p> <p><u>Note:</u> Check wheel tread in accordance with Chapter A 1.6.1</p>

Appendix 10, Annex 5

VERIFICATION AND HANDLING OF GREASE/OIL DEPOSITS ON WHEELS AND AXLE BOXES

Concerns wagons withdrawn from service due to loss of lubricant or on which a lubricant leak is recorded in the context of an axle/running gear inspection (e.g., EVIC).

General remark:

The procedure described hereafter must only be applied if no “hot box” or “temperature” notification has been issued by the hot box detection system!

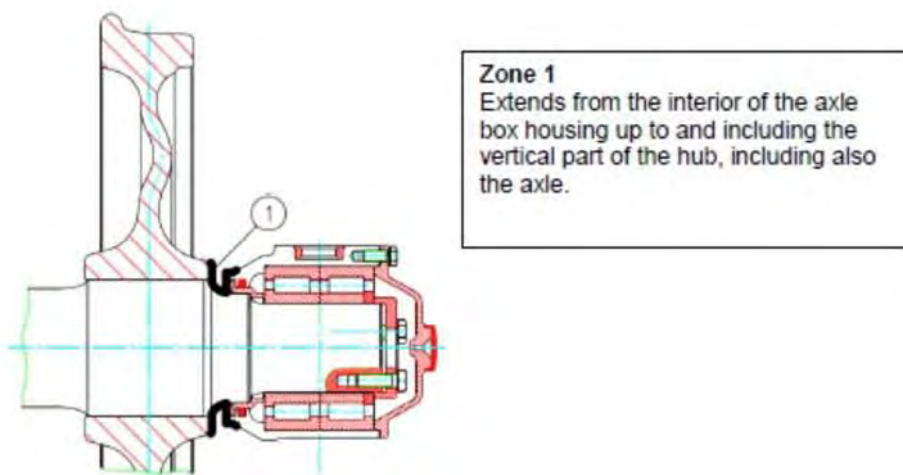

Lubricant on the axle box housing – zone 1

Axles with grease or oil in “zone 1” may remain under the wagon subject to the following measures being taken in the locations concerned:

Measures to be taken:

- The wagon’s keeper must be informed. It is the keeper’s job to provide instructions to apply a marking to the axle or to enter it in the axle database, and to decide whether the axle may remain under the wagon or whether it should be replaced.
- If the keeper says the axle can remain under the wagon, the excess grease/oil is to be wiped away.

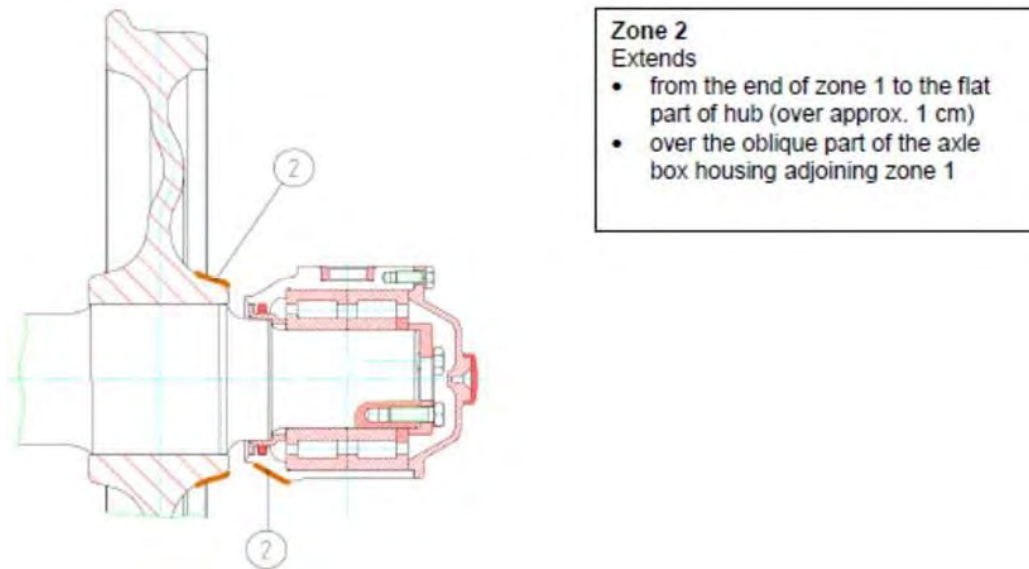

Lubricant on the axle box housing – zone 2

Axles with grease or oil in “zone 2” may remain under the wagon subject to the following measures being taken in the locations concerned:

Measures to be taken:

- The wagon’s keeper must be informed. It is the keeper’s job to provide instructions to apply a marking to the axle or to enter it in the axle database, and to decide whether the axle may remain under the wagon or whether it should be replaced.
- If the keeper says the axle can remain under the wagon, the excess grease/oil is to be wiped away.

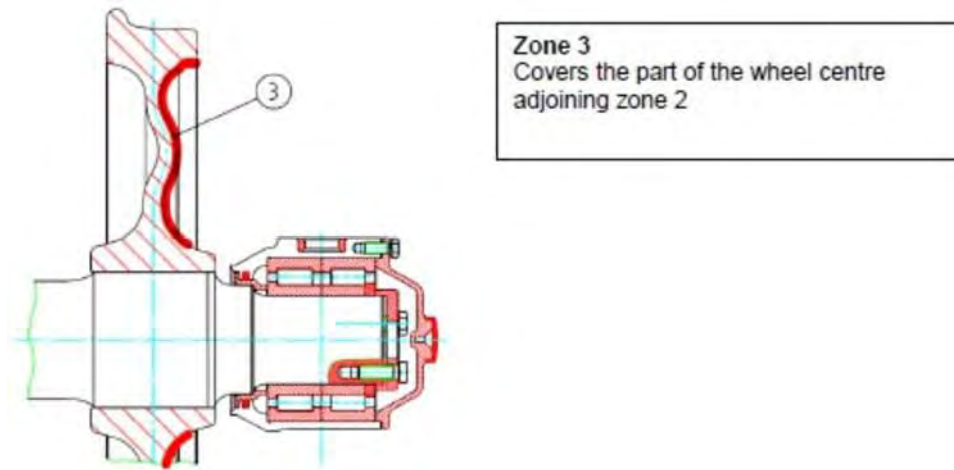

Projections of oil/grease on the axle box housing – zone 3

For axles with lubricant projections on the wheel centre in “zone 3”, **IF THESE PROJECTIONS DO NOT EMANATE FROM the hub or the axle box but begin beyond the axle box housing,**

or

if traces of lubricant, emanating radially from the axle box housing, are observed scattered irregularly across “zone 3”, the axles may remain under the wagon subject to the following measures being taken in the locations concerned:

Measures to be taken:

- The wagon’s keeper must be informed. It is the keeper’s job to provide instructions to apply a marking to the axle or to enter it in the axle database, and to decide whether the axle may remain under the wagon or whether it should be replaced.
- If the keeper says the axle can remain under the wagon, the excess grease/oil is to be wiped away.

Oil/grease leakage distributed regularly across the whole wheel centre circumference – zone 3

If the lubricant emanates radially from the axle box housing and spreads in a uniform manner across the wheel body, wheel centre or intersection between the wheel body and tyred rim, the axle must be removed and replaced, applying Label H^R.

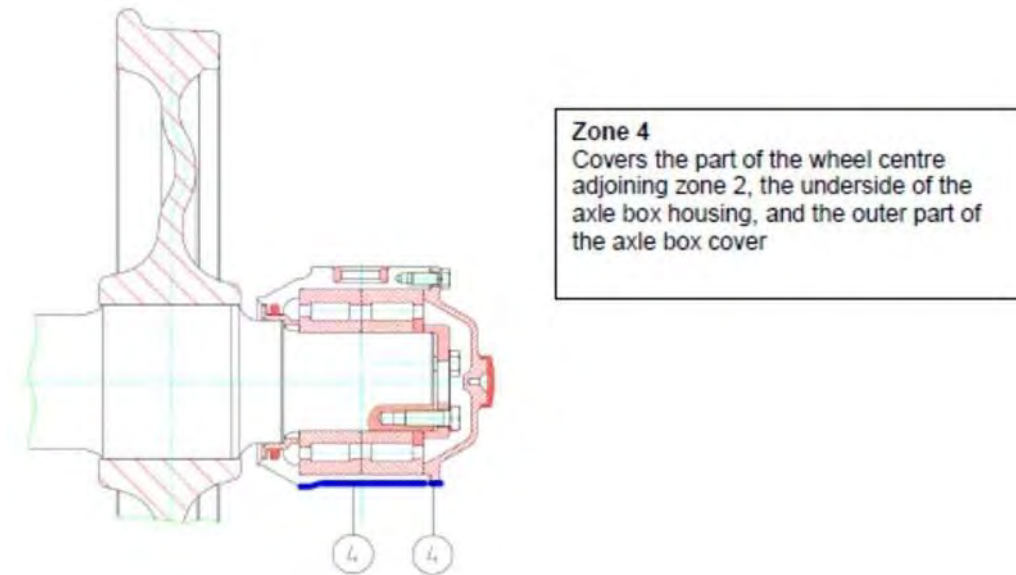

Oil/grease leakage on the bottom of the axle box housing – zone 4

If lubricant is observed in “zone 4”, the location from where the grease/oil is leaking is to be identified. The procedure to be applied varies depending on the origin of the problem:

- the grease/oil emanates from zones 1 and 2, within the axle box housing, and is leaking underneath the axle box housing,
- there are traces of grease/oil on the axle box cover, running under the axle box housing,
- the axle box housing is cracked/broken.

Measures to be taken if points a or b apply:

- The wagon’s keeper must be informed. It is the keeper’s job to provide instructions to apply a marking to the axle or to enter it in the axle database, and to decide whether the axle may remain under the wagon or whether it should be replaced.
- If the keeper says the axle can remain under the wagon, the excess grease/oil is to be wiped away.

Measure to be taken if point c applies:

- Remove the axle from the wagon concerned and replace it, applying Label H^R.

Appendix 10, Annex 6

CODING OF INTERVENTIONS

This list comprises the interventions possible under the GCU. They must be communicated to the keeper by the RU or its auxiliary performing the work, using the coding given in column 2. All codes of the interventions are to be communicated. Codes shall be indicated on the invoice and/or sent separately to the keeper. The wagon number, workshop name and date of entry to/exit from the workshop must be at least indicated as basic data.

Any additional information necessary and measurement values may be communicated with the codes or in a separate list. All reports mentioned shall be sent immediately.

Structure of the list:

Column 1, GCU intervention code: the intervention codes shall be sent to the keeper.

Example meaning of code: CU12345

CU:	Indicates that the code belongs to the GCU, Appendix 10	
1:	Section of the GCU Appendix 9 or Appendix 10	
234:	Sequence number	
5:	Substance of intervention	0: inspection 1: repair, reset (without welding) 2: exchange 3: weld

Column 2, action: description of action. May, if so desired, be sent with intervention code.

Column 3, other vital information: the measurement values indicated, position-related data, and any reports shall be communicated to the keeper.

Column 4, inspection as per Appendix 9: intervention corresponds to damage as described in Appendix 9 to the GCU.

Column 5, inspection as per Appendix 10: intervention corresponds to damage as described in Appendix 10 to the GCU.

GCU intervention code	Intervention(s)	Any additional information necessary	Technical Inspection as per Appendix 9	Rules as per Appendix 10
CU10010	Measure wheelset in accordance with points in section A1	axle number, value, measuring point	1.1.1, 1.3.1, 1.4, 1.7.1	1.1-1.6, 1.9, 1.18, 1.19
CU10012	Replace wheelset if values measured not within tolerances	axle number, form H ^R , value, measuring points		1.1-1.6, 1.9, 1.18, 1.19
CU10020	Visually inspect wheelset	axle number,	1.2.1, 1.3.2, 1.6.1, 1.6.3, 1.8.2	1.6-1.8, 1.10-1.15.1
CU10022	Replace wheelset following visual inspection	axle number, form H ^R	1.5	1.6-1.8, 1.10-1.15.1
CU10150	Check against EVIC			1.15.2
CU10152	Replace wheelset following EVIC inspection	Axle number, Form H ^R		1.15.2
CU10160	Check that tyre is not loose		1.1.2-1.1.6	1.16
CU10162	Replace wheelset following check that tyre has not come loose	axle number, form H ^R		1.16
CU10170	Measure wheelset in accordance with 1.17 (three-point measurement)	axle number, values		1.17
CU10172	Replace wheelset if values measured fall outside 1.17 tolerances	axle number, form H ^R		1.17
CU10180	Test for overheating			1.18
CU10181	Thermally overloaded thermostable wheelsets without wheelset replacement	axle number		1.18
CU10200	Check there is no loss of grease/oil	axle number, position of axle box	1.8.1	1.20
CU10201	Wipe clean any lubricant loss as per Annex 5	axle number, position of axle box		1.20
CU10281	Reprofile monobloc wheel	axle number, value, measurement report		1.28
CU10322	Replace wheelset following hot box	axle number, form H ^R	1.2.2.2, 1.8.3	1.32
CU20010	Visually inspect leaf-spring suspension	position of axle box,	2.1.1-2.1.4, 2.1.6	2.1, 2.2, 2.4, 2.7
CU20012	Replace leaf-spring suspension spring	position of axle box, form H, indicate reason for change	2.1.1-2.1.4, 2.1.6	2.1, 2.2, 2.4, 2.7
CU20030	Check helical springs	position of axle box,	2.5.1, 2.5.2.x	2.3, 4.20-4.23
CU20032	Replace helical spring	position of axle box, form H, indicate reason for change		2.3, 4.20-4.23
CU20050	Check distance between spring buckle and fixed part of bogie frame or wagon	position of axle box,	2.1.5, 2.5.6	2.5
CU20051	Rectify distance between spring buckle and fixed part of bogie frame or wagon	position of axle box,	2.1.5, 2.5.6	2.5
CU20060	Check for contact marks between spring buckle and fixed part of bogie frame or wagon	position of axle box,	2.4.4, 2.5.6	2.6
CU20061	Rectify causes and paint any contact marks between spring buckle and fixed part of bogie frame or wagon	position of axle box, detail activities	2.4.4, 2.5.6	2.6
CU20080	Check elements composing the elastic suspension	position of axle box,	2.4.2- 2.4.4	2.8
CU20082	Replace elements composing the elastic suspension	position of axle box, indicate reason for change	2.4.2- 2.4.4	2.8
CU20092	Replace suspension spring shaft	position of axle box, indicate reason for change	2.4.3	2.8
CU30030	Check main brake pipe			3.3
CU30040	Check disc brake indicator			3.4
CU30050	Check brake rigging and mechanical parts		3.1.1	3.1-3.2, 3.6, 3.13
CU30060	Check safety stirrups		3.1.2	3.5
CU30061	Right/straighten safety stirrup		3.1.2	3.5

GCU intervention code	Intervention(s)	Any additional information necessary	Technical Inspection as per Appendix 9	Rules as per Appendix 10
CU30062	Replace safety stirrup		3.1.2	3.5
CU30070	Check brake blocks		3.2	3.6-3.8
CU30072	Replace brake blocks		3.2	3.6-3.8
CU30100	Check brake hoses		3.3.2	3.9-3.10
CU30102	Replace brake hoses		3.3.2	3.9-3.10, 3.17
CU30110	Check height of brake hoses relative to rail			3.11
CU30111	Rectify height of brake hoses relative to rail			3.11
CU30120	Check cut-off cock		3.3.5	3.12
CU30121	Replace cut-off cock		3.3.5	3.12
CU30131	Remove or secure damaged or detached brake parts	indicate which parts have been removed or secured		3.13
CU30150	Check handbrake		3.5	3.15
CU30151	Repair handbrake		3.5.1	3.15
CU30190	Perform brake test as per UIC 543-1	brake test report		3.19
CU30200	Inspect brake release pull		3.1.5	3.20
CU30202	Replace brake release pull		3.1.5	3.20
CU30210	Check brake performance after replacing brake blocks and/or wheelsets			1.37, 3.21
CU40010	Check wagon underframe		4.1.1, 4.1.2	4.1
CU40020	Check flanges of solebars, headstocks and intermediate cross-bars subject to stress from the coupler		4.1.1, 4.1.2	4.2
CU40030	Check welding on wagon underframe		4.1.1, 4.1.2	4.3
CU40033	Repair wagon underframe by welding	indication as per EN 15085- 2	4.1.1, 4.1.2	4.3
CU40060	Check spark arrestor plates		3.4	4.6, 4.7
CU40061	Repair spark arrestor plate	position of axle box	3.4	4.6, 4.7
CU40062	Replace spark arrestor plate	position of axle box	3.4	4.6, 4.7
CU40080	Check axle guard and tie		4.2.x, 4.3.1, 4.4.x	4.8-4.10
CU40081	Repair axle guard		4.2.x, 4.3.1	4.8-4.10
CU40082	Replace axle guard		4.2.x, 4.3.1	4.8-4.10
CU40102	Replace axle guard tie	position of axle box	4.2.x, 4.3.1	4.8-4.10
CU40110	Check suspension spring brackets		4.5.1	4.11
CU40111	Repair suspension spring brackets		4.5.1	4.11
CU40112	Replace suspension spring brackets	position of axle box	4.5.1	4.11
CU40120	Check bogies		4.7.x	4.12-4.15
CU40130	Check welds on bogie frames	bogie number or position of axle box	4.7.x	4.12-4.15
CU40133	Repair bogie frame by welding	bogie number or position of axle box	4.7.x	4.12-4.15
CU40140	Check side bearer fastenings		4.8.3	4.14
CU40141	Restore side bearer fastenings to working order		4.8.3	4.14
CU40142	Replace side bearer parts		4.8.3	4.14
CU40160	Check bogie centre casting	bogie number or position of axle box	4.6.1	4.16
CU40162	Replace bogie centre casting	bogie number or position of axle box	4.6.1	4.16

GCU intervention code	Intervention(s)	Any additional information necessary	Technical Inspection as per Appendix 9	Rules as per Appendix 10
CU40170	Check kingpin	bogie number or position of axle box	4.6.1	4.17
CU40172	Replace kingpin	bogie number or position of axle box	4.6.1	4.17
CU40180	Check axle guard guiding surface		4.4.x	4.18
CU40183	Weld axle guard guiding surface	position of axle box	4.4.x	4.18
CU40190	Check earthing braid		4.6.2.x	4.19
CU40191	Attach earthing braid	bogie number or axle box position number	4.6.2.x	4.19
CU40192	Replace earthing braid	bogie number or position of axle box	4.6.2.x	4.19
CU40322	Replace any rivets, screws or bolts which are loose or missing from the axle guard securing	position of axle box		4.32
CU40331	Clean contact surface of the suspension shock absorber	position of axle box		4.33
CU40343	Weld wear plate onto bogie	bogie number or position of axle box		4.34
CU50010	Measure buffing height	height per buffer	5.1.2	5.1
CU50030	Check buffers, "starred points"		5.1.1, 5.2.x, 5.3.x, 5.4.x, 5.5.x	5.3, 5.7, 5.8, 5.9
CU50032	Replace buffer fastening bolt		5.4.4.x	5.3
CU50040	Check buffers: fastening, spring, casing		5.1.1, 5.2.x, 5.3.x, 5.4.x, 5.5.x	5.4, 5.5, 5.6
CU50042	Replace buffers at one end			5.23
CU50081	Lubricate buffer plates		5.2.3.1	5.8
CU50091	Grind buffer plates following detection of grooving		5.2.3.2	5.9.1, 5.9.2
CU50110	Check draw hook and screw coupler		5.6.x	5.11, 5.12, 5.13, 5.14, 5.19
CU50111	Rectify height of screw coupler relative to rail		5.6.3	5.11
CU50132	Replace screw coupler			5.13
CU50141	Lubricate screw coupling			5.14.1
CU50142	Replace draw hook		5.7.1.x	5.13
CU50150	Check draw bar		5.8.1	5.15
CU50170	Check traction		5.6.2	5.17, 5.18
CU50172	Replace traction		5.6.2	5.17, 5.18
CU50200	Check screw coupler dummy hook		5.6.2	5.20
CU50201	Right/straighten screw coupler dummy hook		5.6.2	5.20
CU50202	Replace screw coupler dummy hook		5.6.2	5.20
CU50213	Repair draw bar temporarily by welding			5.21
CU50220	Check shock absorber		5.9.1	5.22
CU50221	Repair shock absorber		5.9.1	5.22
CU50252	Replace damaged or distorted anti-crash device		5.5.2	5.26
CU50262	Replace buffer fitted with damaged or distorted anti-crash device with standard buffer		5.5.2	5.26
CU60020	Check wagon body		6.1.3.x, 6.1.4.x, 6.1.7.9	6.1,6.2
CU60021	Repair wagon body		6.1.3.x, 6.1.4.x	6.2
CU60022	Repair wagon body following gauge-fouling		6.1.3.x,6.1.4.x	6.2
CU60030	Check heating pipes and other connections			6.3
CU60031	Rectify minimum height relative to the rail of the heating pipes and other connections			6.3

GCU intervention code	Intervention(s)	Any additional information necessary	Technical Inspection as per Appendix 9	Rules as per Appendix 10
CU60040	Check moving parts and the devices used to control them			6.4
CU60041	Restore moving parts and the devices used to control them to working order			6.4
CU60050	Check floor		6.1.5.x	6.5
CU60051	Repair floor		6.1.5.x	6.5
CU60060	Check sliding doors and collapsible side walls		6.1.6.x	6.6
CU60061	Restore sliding doors and collapsible side walls to working order		6.1.6.x	6.6
CU60070	Check door locking		6.1.6.x	6.7
CU60071	Restore door locking to working order		6.1.6.x	6.7
CU60080	Check door leak-tightness		6.1.6.x	6.8
CU60081	Restore door leak-tightness to working order		6.1.6.x	6.8
CU60090	Check guiding and locking systems		6.1.6.x	6.9
CU60091	Restore guiding and locking systems to working order		6.1.6.x	6.9
CU60092	Replace guiding and locking systems		6.1.6.x	6.9
CU60100	Check steps and handrails		6.1.7.1-6.1.7.4	6.10, 6.11, 6.12
CU60101	Right/straighten steps and handrails		6.1.7.1-6.1.7.4	6.10, 6.11, 6.12
CU60102	Replace steps and handrails	indicate parts replaced	6.1.7.1-6.1.7.4	6.10, 6.11, 6.12
CU60130	Check label-holder, marking plate, etc.		6.1.7.5,6.1.7.6	6.13
CU60131	Repair label-holder, marking plate, folding board		6.1.7.5,6.1.7.6	6.13
CU60132	Replace label-holder, marking plate, folding board	indicate parts replaced	6.1.7.5,6.1.7.6	6.13
CU60140	Check markings as per Appendix 11		6.1.x, 6.2.x	6.14
CU60141	Render markings compliant		6.1.x, 6.2.x	6.14
CU60150	Check ventilation flaps		6.2.1.x	6.15
CU60151	Repair ventilation flaps		6.2.1.x	6.15
CU60152	Replace ventilation flaps		6.2.1.x	6.15
CU60160	Check control gear and shutter retaining brackets		6.2.2.x	6.16
CU60161	Repair control gear and shutter retaining brackets		6.2.2.x	6.16
CU60162	Replace control gear and shutter retaining brackets		6.2.2.x	6.16
CU60170	Check roof cover and guttering		6.2.3	6.17
CU60171	Repair roof cover and guttering		6.2.3	6.17
CU60180	Check opening roof		6.2.4.x	6.18
CU60181	Repair opening roof		6.2.4.x	6.18
CU60190	Check roof hatches		6.2.4.x	6.19
CU60191	Restore roof hatches to working order			6.19
CU60200	Check side door locking		6.3.1.x	6.20
CU60201	Repair side door locking		6.3.1.x	6.20
CU60210	Check end flap/board locking		6.3.1.x, 6.3.2.x	6.21
CU60211	Repair end flap/board locking		6.3.1.x, 6.3.2.x	6.21
CU60222	Replace closing end parts			6.22
CU60230	Check cantrail		6.3.3.x	6.23
CU60231	Repair cantrail		6.3.3.x	6.23
CU60240	Check drop sides		6.4.1.x	6.24
CU60241	Restore drop side to working order		6.4.1.x	6.24
CU60250	Check hinges, pins and securing devices of drop sides		6.4.2.x	
CU60251	Repair hinges, pins and securing device of drop sides		6.4.2.x	6.25
CU60260	Check stanchions		6.4.3.x	6.26, 6.46

GCU intervention code	Intervention(s)	Any additional information necessary	Technical Inspection as per Appendix 9	Rules as per Appendix 10
CU60261	Restore stanchions to working order		6.4.3.x	6.26, 6.46
CU60262	Replace stanchions		6.4.3.x	6.26, 6.46
CU60270	Check folding bolsters		6.4.4.x	6.27
CU60271	Repair folding bolsters		6.4.4.x	6.27
CU60280	Check deformation on tank		6.5.1.x, 6.5.2.x	6.28
CU60285	Check tank, "starred points"		6.5.1.x, 6.5.2.x, 6.5.3.x, 6.5.5.3, 6.5.5.6, 6.5.5.7, 6.5.5.8, 6.5.5.9, 6.5.5.10	6.28-6.32, 6.34, 6.35, 6.37
CU60310	Check ladders, platforms and guard rails			6.31
CU60311	Repair ladders, platforms and guard rails			6.31
CU60320	Check tank cladding, sun-roofs and insulation		6.5.3.x	6.32
CU60321	Repair tank cladding, sun-roofs and insulation		6.5.3.x	6.32
CU60330	Check that tank and their filling and emptying devices do not leak		6.5.5.x	6.33
CU60331	Repair any leaks from tanks and their filling and emptying devices		6.5.5.1	6.33
CU60342	Replace screw cap		6.5.5.3	.634
CU60350	Check blind flange		6.5.5.6, 6.5.5.7, 6.5.5.8, 6.5.5.9	6.35
CU60351	Tighten blind flange		6.5.5.6, 6.5.5.7, 6.5.5.8, 6.5.5.9	6.35
CU60352	Replace blind flange		6.5.5.6, 6.5.5.7, 6.5.5.8, 6.5.5.9	6.35
CU60360	Check emergency control screw		6.5.5.12	6.36
CU60370	Check indicator on emptying valve		6.5.5.10	6.37
CU60380	Check dome hatch		6.5.6.2	6.38
CU60390	Check mechanical sheeting and locking mechanism		6.6.1	6.39
CU60391	Restore mechanical sheeting and locking mechanism to working order		6.6.1	6.39
CU60400	Check hood locking system		6.6.2.x	6.40
CU60401	Restore hood locking system to working order		6.6.2.x	6.40
CU60410	Check moving headstock		6.6.3.1, 6.6.3.2	6.41
CU60411	Restore moving headstock to working order		6.6.3.1, 6.6.3.2	6.41
CU60420	Check seating device, seating device bolts, securing chains and chain eyes		6.6.3.3 6.7.1.1 6.7.1.2 6.7.2	6.42
CU60421	Restore seating device, seating device bolts, securing chains and chain eyes to working order		6.6.3.3 6.7.1.1 6.7.1.2 6.7.2	6.42
CU60430	Check swivel frame (ACTS)		6.6.4.1, 6.6.4.5, 6.6.4.6	6.43
CU60431	Restore swivel frame (ACTS) to working order		6.6.4.1, 6.6.4.5, 6.6.4.6	6.43
CU60440	Check snap locks (ACTS)		6.6.4.2	6.44
CU60441	Restore snap locks (ACTS) to working order		6.6.4.2	6.44
CU60450	Check central lock (ACTS)		6.6.4.4	6.45
CU60451	Restore central lock (ACTS) to working order		6.6.4.4	6.45
CU60470	Check end boards and crossing gangways		6.6.5.3	6.47

GCU intervention code	Intervention(s)	Any additional information necessary	Technical Inspection as per Appendix 9	Rules as per Appendix 10
CU60471	Repair end boards and crossing gangways		6.6.5.3	6.47
CU60472	Replace end boards and crossing gangways		6.6.5.3	6.47
CU60480	Check upper loading deck and indicator de- vice		6.6.5.4, 6.6.5.5, 6.6.5.6, 6.6.5.7	6.48
CU60500	Check valves and hatches		6.6.6.1, 6.6.6.2	6.50
CU60501	Repair valves and hatches		6.6.6.1, 6.6.6.2	6.50
CU60510	Check locking and discharging system			6.51
CU60511	Repair locking and discharging system			6.51
CU61010	Check locking of container spigots			
CU61011	Repair container spigot locking system			
CU61012	Replace container spigot locking system			
CU61020	Check dividing wall			
CU61021	Repair dividing wall			
CU61030	Check securing systems (e.g., hoops)			
CU61031	Repair securing systems (e.g., hoops)			
CU61040	Check detachable accessories		6.1.7.7, 6.1.7.8	
CU61041	Replace detachable accessory with a part from company stocks		6.1.7.7, 6.1.7.8	
CU63900	Mechanical sheeting inspection		6.6.1.2, 6.6.1.3	6.39.1
CU63901	Repair mechanical sheeting		6.6.1.2, 6.6.1.3	6.39.2
CU63930	Inspect elements to hold and fasten sheeting		6.6.1.5	6.39.3
CU63931	Repair elements to hold and fasten sheeting		6.6.1.5	6.39.3
CU77271	Removal and disposal of loading residues	photo of loading residues	7.2.7	0 Principle

Definition of terms:	
Check	Act of assessing, verifying or measuring, and of judging and defining corrective measures.
Position of axle box	Position of the axle as indicated by the marking on the wagon. If there is no such marking, count from one end (choose which) of the wagon.